



USER MANUAL

Multi-zone ART Workstation

Rev. 6.0
Date of revised 09.13.2021
Rx only



 Esco Medical Technologies, Ltd.
Draugystės street 19 • Kaunas, Lithuania
Tel +370 37 470 000
www.esco-medical.com • support-medical@escolifesciences.com

For Technical Service, contact
Europe

Esco Medical Technologies, Ltd.
Draugystės street 19 • Kaunas, Lithuania
Tel +370 37 470 000
www.esco-medical.com • support-medical@escolifesciences.com

North America

Esco Technologies, Inc.
903 Sheehy Drive, Suite F, Horsham, PA 19044, USA
Tel 215-441-9661 • Fax 484-698-7757
www.escolifesciences.us • eti.admin@escoglobal.com

Rest of the World

Esco Micro Pte. Ltd.
21 Changi South Street 1 • Singapore 486 777
Tel +65 6542 0833 • Fax +65 6542 6920
www.escolifesciences.com • mail@escolifesciences.com

Copyright Information

© Copyright 2014 Esco Micro Pte Ltd. All rights reserved.

The information in this manual and the accompanying product is copyrighted and all rights are reserved by Esco.

Esco reserves the right to make periodic minor design changes without obligation to notify any person or entity of such change.

Sentinel™ is a registered trademark of Esco.

Caution: Federal law restricts this device to sale by or on a licensed healthcare practitioner's order.

Only to be used by a trained and qualified professional. The device is sold under exemption 21 CFR 801 Subpart D.

"Material in this manual is provided for informational purposes only. The contents and the product described in this manual (including any appendix, addendum, attachment or inclusion) are subject to change without notice. Esco makes no representations or warranties as to the accuracy of the information contained in this manual. In no event shall Esco be held liable for any damages, direct or consequential, arising out of or related to the use of this manual."

Unpacking and Inspection

Follow standard receiving practices upon receipt of the instrument. Check the shipping carton for damage. If the damage is found, stop unpacking the instrument. Notify the freight carrier and ask for an agent to be present while the instrument is unpacked. There are no special unpacking instructions, but be careful not to damage the instrument when unpacking it. Inspect the instrument for physical damage such as bent or broken parts, dents, or scratches.

Claims

Our routine method of shipment is via common carrier. If physical damage is found, upon delivery, retain all packing materials in their original condition and immediately contact the carrier to file a claim.

If the instrument is delivered in good physical condition but does not operate within specifications, or if there are any other problems not caused by shipping damage, please contact your local sales representative or Esco Medical immediately.

Standard Terms and Conditions

Refunds & Credits

Please note only serialized products (products labeled with a distinct serial number) and accessories are eligible for a partial refund and/or credit. Non-serialized parts and accessory items (cables, carrying cases, auxiliary modules, etc.) do not qualify for return or refund. To receive a partial refund/credit, the product must not have been damaged. It must be returned complete (meaning all manuals, cables, accessories, etc.) within 30 days of original purchase, in “as new” and resalable condition. The *Return Procedure* must be followed.

Return Procedure

Every product returned for refund/credit must be accompanied by a Return Material Authorization (RMA) number obtained from Esco Medical Customer Service. All items being returned must be sent *prepaid* (freight, duty, brokerage and taxes) to our factory location.

Restocking Charges

Products returned within 30 days of original purchase are subject to a minimum restocking fee of 20% of the list price. Additional charges for damage and/or missing parts and accessories will be applied to all returns. Products that are not in “as new” and resalable condition are not eligible for credit return and will be returned to the customer at their own expense.

Certification

This instrument has been thoroughly tested/inspected and found to meet Esco Medical’s manufacturing specifications when shipped from the factory. Calibration measurements and testing are traceable and done according to Esco Medicals ISO certification.

Warranty and Product Support

Esco Medical warrants this instrument to be free from defects in materials and workmanship under regular use and service for two (2) years from the original purchase date. The provided instrument is calibrated and maintained following this manual. During the warranty period, Esco Medical will, at our option, either repair or replace a product that proves to be defective at no charge, provided you return the product (shipping, duty,

brokerage and taxes prepaid) to Esco Medical. Any transportation charges incurred are the purchaser's responsibility and are not included within this warranty. This warranty extends only to the original purchaser. It does not cover damage from abuse, neglect, accident or misuse, or as the result of service or modification by parties other than Esco Medical.

IN NO EVENT SHALL ESCO MEDICAL LTD. BE LIABLE FOR CONSEQUENTIAL DAMAGES. No warranty shall apply when any of the following causes damage:

- Power failure, surges, or spikes
- Damage in transit or when moving the instrument
- An improper power supply such as low voltage, incorrect voltage, defective wiring or inadequate fuses
- Accident, alteration, abuse or misuse of the instrument
- Fire, water damage, theft, war, riot, hostility, acts of God such as hurricanes, floods, etc.

Only serialized products (those items bearing a distinct serial number tag) and their accessory items are covered under this warranty.

PHYSICAL DAMAGE CAUSED BY MISUSE OR PHYSICAL ABUSE IS NOT COVERED UNDER THE WARRANTY. Items such as cables and non-serialized modules are not covered under this warranty.

This warranty gives you specific legal rights and you may have other rights, which vary from province to province, state to state, or country to country. This warranty is limited to repairing the instrument per Esco Medical's specifications.

When you return an instrument to Esco Medical for service, repair or calibration, we recommend shipment using the original shipping foam and container. If the original packing materials are not available, we recommend the following guide for repackaging:

- Use a double-walled carton of sufficient strength for the weight being shipped
- Use heavy paper or cardboard to protect all instrument surfaces. Use non-abrasive material around all projecting parts
- Use at least four inches of tightly packed, industrial-approved, shock-absorbent material all around the instrument

Esco Medical will not be responsible for lost shipments or instruments received in damaged condition due to improper packaging or handling. All warranty claim shipments must be made on a prepaid basis (freight, duty, brokerage, and taxes). No returns will be accepted without a Return Materials Authorization ("RMA") number. Please contact Esco Medical to obtain an RMA number and receive help with shipping/customs documentation.

Re-calibration of instruments, which have a recommended annual calibration frequency, is not covered under warranty.

Warranty Disclaimer

If your instrument is serviced and/or calibrated by someone other than Esco Medical Ltd. and their representatives, please be advised that the original warranty covering your product becomes void when the tamper-resistant Quality Seal is removed or broken without proper factory authorization.

In all cases, breaking the tamper-resistant Quality Seal should be avoided at all cost, as this seal is key to your original instrument warranty. In an event where the seal must be broken to gain internal access to the instrument, you must first contact Esco Medical Ltd.

You will be required to provide us with the serial number for your instrument, as well as a valid reason for breaking the Quality Seal. You should break this seal only after you have received factory authorization. Do not break the Quality Seal before you have contacted us! Following these steps will help ensure that you will retain the original warranty on your instrument without interruption.

WARNING

Unauthorized user modifications or applications beyond the published specifications may result in an electrical shock hazard or improper operation. Esco Medical will not be responsible for any injury sustained due to unauthorized equipment modifications.

ESCO MEDICAL LTD. DISCLAIMS ALL OTHER WARRANTIES, EXPRESSED OR IMPLIED, INCLUDING ANY WARRANTY OF MERCHANTABILITY OR FITNESS FOR A PARTICULAR PURPOSE OR APPLICATION.

THIS PRODUCT CONTAINS NO USER-SERVICEABLE COMPONENTS.

UNAUTHORIZED REMOVAL OF THE INSTRUMENT COVER SHALL VOID THIS AND ALL OTHER EXPRESSED OR IMPLIED WARRANTIES.

Table of contents

- 1 How to use this manual..... 11
- 2 Safety warning..... 11
- 3 Indication for use..... 11
- 4 About the product..... 12
- 5 Transport, Storage and Disposal 13
 - 5.1 Transport 13
 - 5.2 Storage and operation environment requirements..... 13
 - 5.2.1 Storage requirements 13
 - 5.2.2 Operation environment requirements..... 13
 - 5.3 Disposal..... 13
- 6 Supplied service parts and accessories 14
- 7 Safety symbols and labels 15
- 8 Important safety instructions and warnings 16
 - 8.1 Before installation 16
 - 8.2 During installation..... 16
 - 8.3 Post-installation 17
- 9 Getting started..... 17
- 10 Mains connection..... 18
- 11 Gas connection and the humidification system 18
 - 11.1 Multi-zone ART Workstation without compartments 21
 - 11.2 Multi-zone ART Workstation with compartments..... 22
 - 11.3 Multi-zone ART Workstation with compartments and built-in gas mixer 24
- 12 User interface 25
 - 12.1 Activating heat and gas controls 26
 - 12.2 System menu..... 26
 - 12.3 Status..... 26
 - 12.3.1 Models without a built-in gas mixer 26
 - 12.3.2 Models with a built-in gas mixer 27
 - 12.4 Main menu 28
 - 12.4.1 Main menu (only for models without a built-in gas mixer) 28

| | |
|--|----|
| 12.4.2 Main menu (only for models with a built-in gas mixer) | 28 |
| 12.5 Sub-menus | 29 |
| 12.5.1 Temperature sub-menu | 29 |
| 12.5.2 CO ₂ sub-menu (only for models with a built-in gas mixer) | 30 |
| 12.5.3 O ₂ sub-menu (only for models with a built-in gas mixer)..... | 32 |
| 12.5.4 Service sub-menu..... | 33 |
| 13 Alarms | 34 |
| 13.1 Temperature alarms | 35 |
| 13.2 Gas level alarms (only for models with a built-in gas mixer) | 36 |
| 13.2.1 CO ₂ alarms | 36 |
| 13.2.2 O ₂ alarms | 36 |
| 13.3 Gas pressure alarms | 37 |
| 13.3.1 CO ₂ pressure alarm | 37 |
| 13.3.2 N ₂ pressure alarm (only for models with built-in gas mixer) | 37 |
| 13.4 Multiple alarms | 38 |
| 14 Changing the setpoints and heated mode | 38 |
| 14.1 Temperature setpoint..... | 38 |
| 14.2 Gas flow setpoint (only for models without a built-in gas mixer)..... | 39 |
| 14.3 CO ₂ gas concentration setpoint (only for models with a built-in gas mixer)..... | 39 |
| 14.4 O ₂ gas concentration setpoint (only for models with a built-in gas mixer)..... | 39 |
| 14.5 Heated Mode | 40 |
| 15 Surface temperatures and measuring temperature..... | 42 |
| 16 Firmware..... | 44 |
| 17 The Laminar Flow..... | 45 |
| 18 Re-Certification by Service Personnel | 45 |
| 18.1 Cabinet Field Calibration | 46 |
| 18.2 Performing Certification..... | 47 |
| 18.2.1 Setting Cabinet in Maintenance Mode | 47 |
| 18.2.2 Locating the Speed Controller..... | 48 |
| 18.2.3 Nominal Airflow Velocity and Uniformity Test..... | 49 |
| 18.2.4 Particle Count Test | 50 |
| 18.2.5 Heated Zones Temperature Test | 50 |
| 18.2.6 Noise Level Test (Optional for field testing) | 51 |

| | |
|--|----|
| 18.2.7 Light Intensity Test (Optional for field testing) | 52 |
| 18.3 Calibration of Sentinel™ Gold Control | 52 |
| 18.4 Replacement of filter | 53 |
| 18.5 Replacement of blower | 55 |
| 18.6 Replacement of fluorescent lamp and UV lamp | 55 |
| 18.6.1 Replacement of Fluorescent Lamp..... | 55 |
| 18.6.2 Replacement of UV Lamp..... | 56 |
| 19 Cleaning instructions | 56 |
| 19.1 Considerations about a sterile device | 56 |
| 19.2 Manufacturer recommended cleaning procedure..... | 56 |
| 19.3 Manufacturer recommended disinfection procedure..... | 57 |
| 20 Heat optimization plates..... | 57 |
| 21 Humidification | 58 |
| 22 Temperature validation | 58 |
| 23 All in one PC | 59 |
| 23.1 Data Logger Software | 60 |
| 24 Maintenance | 67 |
| 25 Emergency Procedures..... | 68 |
| 26 User Troubleshooting | 69 |
| 27 Specifications..... | 70 |
| 28 Electromagnetic compatibility | 72 |
| 29 The Validation guide..... | 75 |
| 29.1 Product release criteria | 75 |
| 29.1.1 Performance..... | 75 |
| 29.1.2 Electrical safety..... | 75 |
| 29.1.3 Communication & data logging | 75 |
| 29.1.4 Gas concentration levels and consumption (only for models with a built-in gas mixer)..... | 75 |
| 29.1.5 Communication & data logging | 76 |
| 30 Validation on-site..... | 76 |
| 30.1 Mandatory equipment..... | 76 |
| 30.2 Recommended additional equipment..... | 77 |
| 31 Testing | 77 |

| | |
|--|----|
| 31.1 Gas supply premixed CO ₂ /O ₂ | 77 |
| 31.2 Gas supply CO ₂ (only for models with a built-in gas mixer)..... | 78 |
| 31.2.1 About CO ₂ | 78 |
| 31.3 Gas supply N ₂ (only for models with a built-in gas mixer)..... | 79 |
| 31.3.1 About N ₂ | 80 |
| 31.4 Premixed gas pressure check..... | 80 |
| 31.5 CO ₂ gas pressure check (only for models with a built-in gas mixer)..... | 81 |
| 31.6 N ₂ gas pressure check (only for models with a built-in gas mixer)..... | 81 |
| 31.7 Voltage supply..... | 81 |
| 31.8 Temperature check: Heating system zones..... | 82 |
| 31.9 6-hour stability test..... | 82 |
| 31.10 Cleaning..... | 83 |
| 31.11 Test documentation form..... | 83 |
| 31.12 Recommended additional testing..... | 84 |
| 31.12.1 A VOC meter..... | 84 |
| 31.12.2 A laser particle counter..... | 84 |
| 32 Clinical use..... | 84 |
| 32.1 Temperature check..... | 85 |
| 32.2 Premixed, CO ₂ and O ₂ gas concentration check..... | 85 |
| 32.3 Premixed, CO ₂ and O ₂ gas pressure check..... | 86 |
| 33 The Maintenance guide..... | 86 |
| 33.1 HEPA in-line filter for premixed gas..... | 87 |
| 33.2 HEPA in-line filter for CO ₂ gas..... | 87 |
| 33.3 HEPA in-line filter for N ₂ gas..... | 88 |
| 33.4 O ₂ sensor (only for models with a built-in gas mixer)..... | 88 |
| 33.5 CO ₂ sensor (only for models with a built-in gas mixer)..... | 89 |
| 33.6 Gas box (only for models without a built-in gas mixer)..... | 90 |
| 33.7 Internal gas pump..... | 90 |
| 33.8 Proportional valves..... | 90 |
| 33.9 Gas lines..... | 91 |
| 33.10 Flow sensors..... | 91 |
| 33.11 Pressure regulators..... | 92 |
| 33.12 Internal 0.2µ filter for premixed gas..... | 92 |

| | |
|---|-----|
| 33.13 Internal 0.2 μ filter for CO ₂ gas | 93 |
| 33.14 Internal 0.2 μ filter for N ₂ gas..... | 93 |
| 33.15 Firmware update | 93 |
| 34 The Installation guide | 94 |
| 34.1 Responsibilities..... | 94 |
| 34.2 Before installation..... | 94 |
| 34.3 Preparing for installation..... | 95 |
| 34.4 Bring the following to the installation site | 95 |
| 34.5 Installation procedure at the site..... | 95 |
| 34.6 Installation procedure: Workstation | 98 |
| 34.7 User training..... | 100 |
| 34.8 After the installation | 100 |

1 How to use this manual

The manual is designed to be read by sections and not ideally from cover to cover. It means that if the manual is read from start to finish, there will be some repetition and overlap. We recommend the following method for going through the manual: first, familiarize yourself with the safety instructions; then, proceed to the essential user functions needed for operating the equipment on a day-to-day basis; then, review the alarm functions. The menu functions of the user interface detail information that is required only for advanced users. All parts must be read before the device is taken into use. The Validation guide is detailed described in sections 29 – 32. The Maintenance guide is detailed described in section 33. The Installation procedures are detailed described in section 34.

2 Safety warning

- Anyone working with, on or around this equipment should read this manual. Failure to read, understand and follow the instructions given in this documentation may result in damage to the unit, injury to operating personnel, and/or poor equipment performance
- Any internal adjustment, modification or maintenance to this equipment must be undertaken by qualified service personnel
- If the equipment must be relocated, make sure it is appropriately fixed on a support stand or base, and move on a flat surface. When necessary, move the equipment and the support stand/base separately
- The use of any hazardous materials in this equipment must be monitored by an industrial hygienist, safety officer or other suitably qualified individuals. Before you proceed, you should thoroughly understand the installation procedures and take note of the environmental/electrical requirements
- In this manual, important safety-related points will be marked with the following symbols:



NOTE

It is used to direct attention to a specific item.



WARNING

Use caution.

- If the equipment is used in a manner not specified by this manual, the protection provided by this equipment may be impaired.

3 Indication for use

The Multi-zone ART Workstation is a laminar flow workstation intended to work with gametes and/or embryos at or near body temperature during in vitro fertilization

(IVF)/assisted reproduction technology (ART) procedures. The workstation also provides humidified gas to maintain gametes and embryos in the working environment.

4 About the product

The Multi-zone ART Workstation is a laminar flow workstation intended to work with gametes and/or embryos at or near body temperature during *in vitro* fertilization (IVF)/assisted reproduction technology (ART) procedures. The workstation also provides humidified gas to maintain gametes and embryos in the working environment.

The 12-zone heating system (8 x table plate and 4 x compartments) gives ideal temperature conditions compared to conventional layouts.

The system has 12 separate temperature controllers for maximum performance, controlling and regulating each zone's temperature.

The workstation has been primarily developed and designed to provide short-term tissue, gametes and embryos with an overlay of either Paraffin or mineral oil, incubation storage conditions.

If open culture is used, the user can utilize the humidified gas system built into the tabletop. The dish is placed under the gas hood where the pH conditions in a buffered media without oil overlay can be maintained.

 **Open culture may lead to evaporation and a change in pH if the correct conditions are not maintained.**

An integral part of the Multi-zone ART Workstation is the All-in-one PC, which runs with the Workstation logger software. The software functions as a constant surveillance system that will give the user early warnings if any parameter drifts beyond safe limits. The software includes data logging, data storage and report functions for ISO quality management compliance. The All-in-one PC can also be used for microscope camera imaging. Using a microscope camera will still warn the user by bringing an alarm notification to the screen while working with the microscope camera imaging.

The device is manufactured under a full EU certified ISO quality management system.

This product fulfills EN60601-1 3rd edition standards as a Class I type B equivalent device suited for continuous operation. It also conforms to the EU Council directive's 2017/745 requirements concerning medical devices and is classified as a Class I device under annex VIII rule 13.

Personal Protective Equipment (89/686/EEC) and Machine Directive (2006/42/EC) is

not applicable for Multi-zone ART Workstation.

5 Transport, Storage and Disposal

5.1 Transport

The devices are packed in a carton box, and it is wrapped to a polyethylene. The box is affixed to a pallet with special straps.

A visual inspection should be done if there is any damage. If there was no damage found, the Multi-Zone ART Workstation is prepared to be transported.

These labels should be glued on the box:

- Label with the marked packing date

5.2 Storage and operation environment requirements

5.2.1 Storage requirements

The device may only be used under the following conditions:

- The unit can be in storage for one year. If stored longer than one year, the unit must be returned to the manufacturer for a new release test
- The unit can be stored at temperatures between -20 °C and + 50 °C
- Keep away from direct sunlight
- Caution: consult the accompanying documents for important safety-related information such as warnings and precautions that cannot be presented on the device itself for various reasons.
- Do not use if the packing material is damaged
- Keep dry

5.2.2 Operation environment requirements

The device may only be used under the following conditions:

- Environmental temperatures below 30 °C
- Away from direct sunlight
- Kept dry
- For indoor use only

5.3 Disposal

Information on the handling of the unit as per the WEEE Directive (Waste Electrical and Electronic Equipment).



The device may have been used for treating and processing infectious substances. Therefore, the device and device components may be contaminated. Prior to disposal, the whole device must be disinfected or decontaminated.

The unit contains reusable materials. All components (except for the HEPA filters) can be discarded as electrical waste after cleaning and disinfection.

Please note that the HEPA filters must be discarded following the applicable national regulations for special solid waste.

6 Supplied service parts and accessories

Service parts:

- 1 HEPA filter for input gas supply (2 x HEPA filters for Multi-zone ART Workstation with gas mixer)
- 1 USB stick containing Esco Medical Datalogger software and PDF versions of the manuals
- 1 gas hood (Multi-zone ART Workstation without compartments) – 2 gas hoods for Multi-zone ART Workstation 6ft Dual
- 1 carry tray (for 1 Multi-zone ART Workstation work zone; Multi-zone ART Workstation with compartments – 1 carry tray for each compartment)
- 1 humidification bottle for Multi-zone ART Workstation 4 ft or 2 humidification bottles for Multi-zone ART Workstation 6 ft Dual
- 2 medical grade power cords for the Multi-zone ART Workstation 4 ft, or 3 medical grade power cords for Multi-zone ART Workstation 6ft Dual

Accessories do not apply with the Multi-zone ART Workstation.

7 Safety symbols and labels

Several user labels on the surface of the Multi-zone ART Workstation guide the user. User labels are shown below.





Table 7.1 Packing box and electrical safety labels

| Description | Image |
|--|--|
| <p>Packing box label:</p> <ol style="list-style-type: none"> 1. If stored longer than the shelf life, the unit must be returned to the manufacturer for a new release test. 2. Shipping temperature between -20 °C and +50 °C. 3. Keep away from direct sunlight. 4. Caution: consult the accompanying documents for important safety-related information such as warnings and precautions that cannot be presented on the device itself for various reasons. 5. Consult instructions for proper use of the device. 6. Do not use it if the packing material is damaged. 7. Rx Only. 8. Keep dry. | <p>This device must be installed before _____ else contact the manufacturer</p> <p>1: Text above the label</p> <p>2: -20°C symbol</p> <p>3: +50°C symbol</p> <p>4: Caution symbol (exclamation mark in triangle)</p> <p>5: Information symbol (i in circle)</p> <p>6: Recycle symbol</p> <p>7: Rx Only symbol</p> <p>8: Keep dry symbol (umbrella with rain)</p> |
| <ol style="list-style-type: none"> 1. Consult instruction for use. 2. Warning on the back of the device indicates that an earth connection is needed and the mains information and an “ON/OFF” push button. 3. “Lightning bolt” indicates the potential risk of electrical shock (never remove any cover). | <p>1: Information symbol (i in circle) Operating instructions</p> <p>2: Warning: equipment must be earthed</p> <p>3: Lightning bolt symbol 220- 240 V, 50/60Hz, 553W</p> <p>Fuses: 2xT3.15A-250V</p> |

Table 7.2 Device label

| Description | Image |
|---|--|
| <ol style="list-style-type: none"> 1. Model. 2. Mains power rating. 3. CE mark. 4. Not protected against the ingress of water. 5. Manufacturer’s address and country of origin. 6. View instruction for use. 7. Observe WEEE. 8. Upper limit of temperature. 9. Keep away from direct sunlight. 10. Keep dry. 11. Logo and serial number. 12. Year of manufacture. 13. Rx only | <p>Multi-zone ART Workstation</p> <p>1: MODEL: MAW- 6D8</p> <p>2: MAINS: 220- 240 V, 50/60 Hz, 965W</p> <p>3: CE mark</p> <p>4: IPX0</p> <p>5: Esco Medical Technologies Draugystes 19, Kaunas 51230 Lithuania</p> <p>6: Information symbol (i in circle) Consult instruction for use</p> <p>7: WEEE symbol (crossed-out trash bin)</p> <p>8: 30°C symbol Upper limit of temperature</p> <p>9: Keep away from direct sunlight</p> <p>10: Keep dry symbol (umbrella with rain)</p> <p>11: ESCO MEDICAL logo</p> <p>12: 2021</p> <p>13: Rx Only</p> <p>11: SN: _____</p> |

Table 7.3 Labels on the Multi-zone ART Workstation

| Description | Image |
|--|---|
| PT 1000 validation sensors |  |
| PC on/off button |  |
| Compartments numbers are indicated in the top corner of the lid with a label (only Multi-zone ART Workstation with compartments) |  |
| Gas inlet on table plate (only Multi-zone ART Workstation without compartments) |  |
| Ethernet |  |

8 Important safety instructions and warnings

8.1 Before installation

1. Do not use the product if the package is damaged. Contact Esco Medical or the local representative.
2. Read the User manual thoroughly before use.
3. Always keep these instructions easily accessible near the device.
4. Do not try to lift heavy equipment alone.
5. If a forklift is used, only lift on the custom-built pallet. The tabletop itself cannot withstand any lifting in the middle. Permanent damage will occur. Warranty void if this happens.
6. The electronics box under the tabletop is not flush with the rest of the underside. Any blows can result in permanent damage. Warranty void if this happens.

8.2 During installation

1. Never place this unit on top of other equipment that might heat it.
2. Place this unit on a flat, hard and stable surface.
3. Never place the unit on a carpet or similar surfaces.
4. Do not defeat the safety purpose of the grounding-type (earthing) plug.
5. A grounding-type (earthing) plug has two blades and a third prong is provided for your safety. If the provided plug does not fit into your outlet, consult an electrician to replace the outlet.
6. Always connect the power cord to a properly grounded outlet and only use the cord that came with the device.

7. Do not install the device near any heat sources such as radiators, heat registers, stoves or other apparatus that produce heat.
8. Do not use this device near water sources.
9. Always use an external HEPA filter for input CO₂ or premixed gases.
10. Do not use this product at temperatures exceeding 30°C.
11. Place this unit in a location with adequate ventilation to prevent internal heat build-up. Leave at least 10 cm clearance from the rear, 30 cm from the top and 20 cm from left and right to prevent overheating and allow access to the ON/OFF switch in the back.
12. This unit is intended for indoor purposes only.
13. Read the section about EMC in this User manual on section 28 and heed the warnings.

8.3 Post-installation

1. Refer all servicing to qualified service personnel.
2. Servicing is required according to the service manual and when the device has been damaged in any way, e.g., if the apparatus has been dropped, exposed to rain or moisture, or does not operate normally. The Multi-zone ART Workstation contains high voltage components that may be hazardous.
3. Unplug this device during lightning storms or when unused for an extended period of time.
4. Protect the power cord from being walked on or pinched, particularly at the plug, convenience receptacles and the point where it exits from the apparatus.
5. Perform temperature and gas calibration at the intervals described in the manuals.
6. NEVER block gas supply holes in the tabletop.
7. Ensure that CO₂ or premixed gas supply pressures are kept stable between 0.4 – 0.6 bar (5.80 – 8.70 PSI).

9 Getting started



The Multi-zone ART Workstation must be installed by authorized and trained personnel only!

1. Follow the guidelines in the safety instructions and warnings section.
2. Connect the mains cable to the top of the Workstation for the fan unit to work.
3. Connect the mains cable to the tabletop's underside for the PC and tabletop heating system to work.
4. Connect the gas lines.
5. Set gas pressure on the external gas regulator between 0.4 – 0.6 bar (5.80 – 8.70 PSI).

6. Switch on the Multi-zone ART Workstation with the switch under the tabletop (next to the mains cable).
7. Power up the PC by pressing the button in the middle of the inner wall work area.
8. Observe for standard functionality.
9. Let the unit warm up and stabilize for 20 min.
10. Follow the guidelines in the Validation guide.
11. Complete user training and finish reading instructions.
12. After a burn-in phase of 24-hours, the unit is ready to be used IF testing is successful.

 **Clean and disinfect the device before use. It is not delivered sterile or in a clinically acceptable clean state. Look through the cleaning instructions section in this manual for the manufacturer's recommended guidelines!**

10 Mains connection

The Multi-zone ART Workstation comes with a detachable mains power cord. The power cord is prepared for the country in which the unit is intended to be used.

 **Do not defeat the safety purpose of the grounding-type plug! A grounding-type plug has two blades and a prong, which is provided for your safety. If the provided plug does not fit into your outlet, consult an electrician to replace the outlet.**

The power requirement is 230V 50 Hz OR 115V 60Hz. The built-in power supply has a switch-mode that automatically adjusts to the correct mains power between 100V-250V AC 50-60 Hz.



Figure 10.1 Power supply

11 Gas connection and the humidification system

Under the SINGLE tabletop, one single gas input (black and blue) is located, whereas, under the DUAL tabletop, two single gas inputs are located.

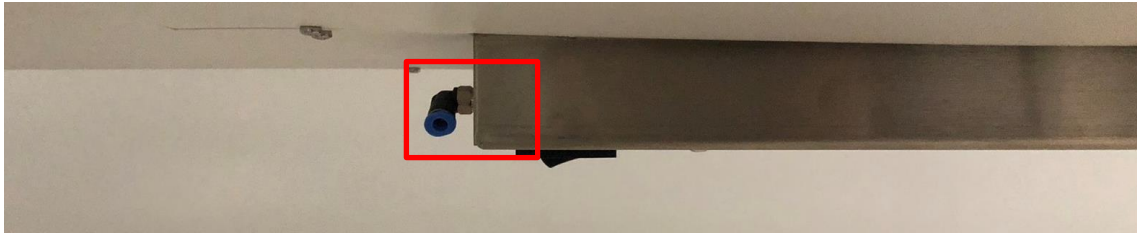

Figure 11.1 Gas inlet under Single tabletop

👉 Gas pressure for inlet should be 0.4 – 0.6 bar (5.80 – 8.70 PSI) and it must be kept stable!

Always use a high-quality pressure regulator for both gases that can be set with the required precision.



Figure 11.2 Pressure regulator

Connect the CO₂ gas to the CO₂ inlet with a suitable silicone tube. Ensure the tube is fastened with a clip so that it does not accidentally loosen itself during sudden pressure fluctuation. Use the supplied 0.2μ HEPA filter on the gas line before the inlet on the Multi-zone ART Workstation. Notice the flow direction.



Figure 11.3 Gas filter

The CO₂ inlet should be connected to a 5.0% or 6.0% premixed CO₂.

The gas flow can be controlled digitally with the keys on the tabletop.

The gas will pass through the humidification system.



Figure 11.4 Humidification flask

Humidification flask tubes are marked with the number 1 and 2. Some have labeled two outlets. Flask tubes must be connected to outlets according to their number (number “1” tube and connect to the outlet marked with the same number).



Figure 11.5 Tubes connected to the flask

👉 If no humidification is required or wanted, a U-looped silicone tube must be put from the port marked “Outlet” to the port below, or simply empty bottle without water installed.

Fill the flask with sterile water.

👉 One-third of the humidification bottle should be filled with sterile water for the Multi-zone ART Workstation to work properly and maintain the required humidity in the system.

👉 Water in the humidification bottle must be changed at least once per week.

11.1 Multi-zone ART Workstation without compartments

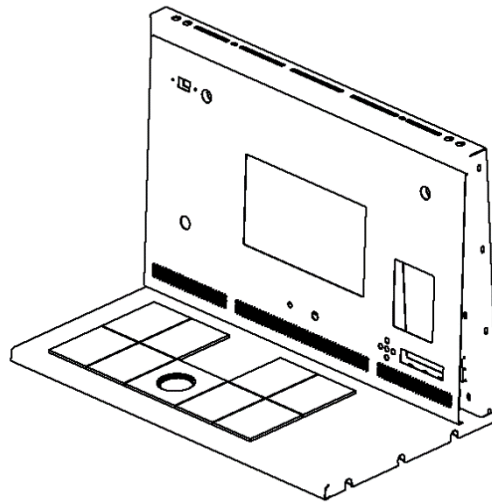

Figure 11.6 Choose gas from the nozzle

The gas will flow through the nozzle in the tabletop work area.



Figure 11.7 Gas nozzle in tabletop

A gas hood must be placed over the outlet. The constant flow will flush the environment so that a correct CO₂ concentration can be kept and thus, no pH drift will occur.



Figure 11.8 Gas hood placed over the gas nozzle

Keep the lids on the dishes when they are placed under the gas hood. The dishes can be placed directly on the warmed surface. A heating optimization plate can also be used. With the Carry Tray, several dishes can be conveniently being transported between a CO₂ incubator and the Multi-zone ART Workstation.



Figure 11.9 Carry Tray

11.2 Multi-zone ART Workstation with compartments

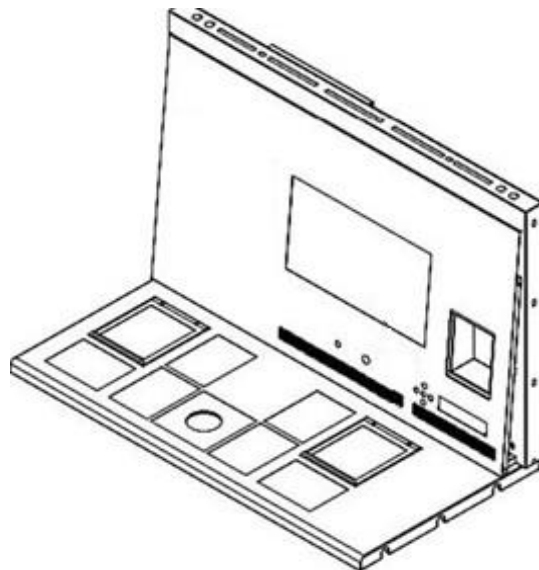

Figure 11.10 Multi-zone ART Workstation with compartments

The gas will flow through and circuit in both compartments by the internal FAN. The FAN will automatically start when the flow is set.

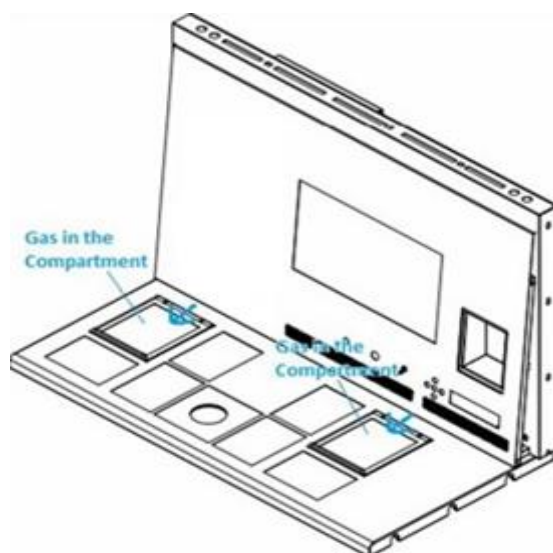

Figure 11.11 Gas in compartments

Gas system overview

Required input gas type: premixed CO₂ gas. Check medium types for the correct mixture and validate the mixture with a gas analyzer before use.

Required input gas pressure: gas pressure on the external source should be 0.4 – 0.6 bar (5.80 – 8.70 PSI) and must be kept stable.

If the pressure falls below 0.3 bar (4.40 PSI) or rises above 0.7 bar (10.20 PSI), it will trigger the gas pressure alarm. If an alarm, remove the sample to a safe CO₂ incubator and investigate the alarm's cause.

The gas flow setpoint can be adjusted in the range from 0 l/h to 40 l/h (with 1 l/h increment).

When the gas flow is active, the user can turn on the “Purge” function by pressing the up (↑) key when the status in the menu shows the “FLW 1”. The gas flow will be switched on for 5 min 40 l/h.

The correct flow is a balance towards maintaining the pH level in the gas usage medium and economy. With increased flow, there is an increased likelihood of correct gas level and fast gas recovery. It also increases gas costs. So, the flow can be adjusted to a level where the medium's pH is still maintained, and the gas consumption is as low as possible. Only a validation test locally can decide this for the specific medium. Also, check the medium manufacturer's recommendations.

11.3 Multi-zone ART Workstation with compartments and built-in gas mixer

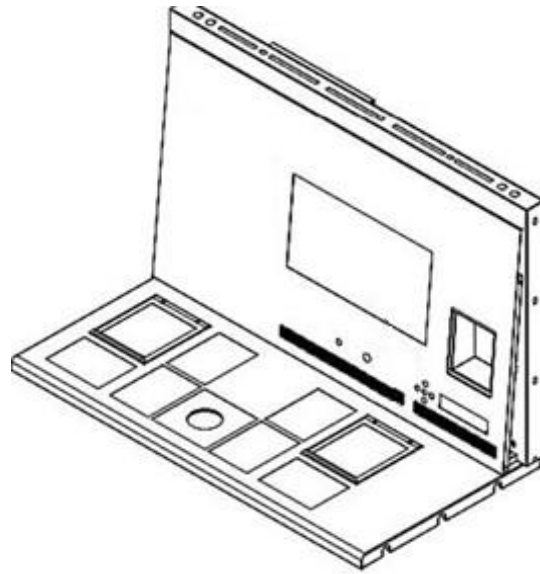

Figure 11.12 Multi-zone ART Workstation with compartments and built-in gas mixer

The gas will flow through and circuit in both compartments by the internal FAN. CO₂ and O₂ sensors will provide gas concentration control.

Gas system overview

Required input gas type: pure CO₂ and N₂ gas. Also, there is a possibility to use premixed CO₂ gas.

Required input gas pressure: gas pressure on the external source should be 0.4 – 0.6 bar (5.80 – 8.70 PSI) and must be kept stable.

If the pressure falls below 0.3 bar (4.40 PSI) or rises above 0.7 bar (10.20 PSI), it will trigger the gas pressure alarm. If an alarm, remove the sample to a safe CO₂ incubator and investigate the alarm's cause.

The CO₂ gas concentration setpoint can be adjusted from 3.0% to 10.0% (with a 0.1 % increment). The N₂ gas concentration setpoint can be adjusted from 5.0% to 20.0%. An audible alarm will start when the gas concentration in compartments differs $\pm 1\%$ from the setpoint.

👉 If premixed gas is intended to be used instead of pure gas, refer to trained personal for help!

👉 The O₂ setpoint must be 2% higher than the premixed gas measured value gas

(i.e., 7.0% if 5.0% measured).

👉 Be advised that premixed gas consumption will be significantly higher compared to pure gas. Recover to the setpoint will be longer.

12 User interface

The main keys and their purpose are presented in table 12.1.

Table 12.1 The main keys and their purpose

| Description | Image |
|--|---|
| <p>Main keys</p> |  |
| <p>ON/OFF keys Located in the REAR of the unit</p> |  |
| <p>Alarm key It is used to mute an audible alarm and visually indicate the alarm condition by a flashing red circle of light. The audio alarm will automatically come back on after 5 min. It can be muted again.</p> |  |
| <p>Display panel Shows the information on the current status of the unit. The display consists of 7 x high brightness 16 segment LEDs. The 1st is red, which indicates a user warning. The other 6 are blue and used to display normal running conditions.</p> |  |
| <p>Setpoint key It is used to select items on the menu to change their status. It is also used to change the temperature and gas setpoints</p> |  |
| <p>Arrow keys up, down & right They are used to navigate through the menu and change the values for temperature and gas concentrations</p> |  |

12.1 Activating heat and gas controls

The main controls are activated using the “ON/OFF” switch under the tabletop.

12.2 System menu

Press and hold (↑) and (↓) keys together for 3 seconds to access the menu.

Navigate in menu using:

- Arrow right (⇒) key = enter
- Up (↑) and Down (↓) arrow keys= previous OR next
- SP/Enter key = change OR accept

Press and hold (↑) and (↓) keys together for 3 seconds to exit the menu entirely.

12.3 Status

12.3.1 Models without a built-in gas mixer

Soon after system activation, the main display will alternate the reading between the following parameters. Scroll between the parameters with the (⇒) key.



There will be an additional culture mode parameter in the Multi-zone ART Workstation and models with compartments. The display will show:



👉 If the use mode is Open Culture (no oil or Paraffin overlay culture), the culture mode shall be set for that and will display:



If the Multi-zone ART Workstation has compartments, after the display shows “TP 37.0”, the user can see the compartment’s temperature by pressing the (↑) key. Then the display will show:



12.3.2 Models with a built-in gas mixer

Soon after system activation, the main display will alternate the reading between the following parameters. Scroll between the parameters with the (⇒) key.



👉 If the O₂ regulator is deactivated, the system will display “O2 OFF”.



If the Multi-zone ART Workstation has compartments, there will be an additional culture mode parameter:



👉 If the use mode is Open Culture (no oil or Paraffin overlay culture), the culture mode shall be set for that and will display:



If the Multi-zone ART Workstation has compartments, after the display shows “TP 37.0”, the user can see the compartment’s temperature by pressing the (↑) key. Then the display will show:



12.4 Main menu

There are two different main menus in the Multi-zone ART Workstation: without a built-in gas mixer and with a built-in gas mixer.

12.4.1 Main menu (only for models without a built-in gas mixer)

Press the (⇒) key to enter the menu.

You can exit the menu by pressing the (↑) key.



Temperature is the first category when you enter the menu.

Press the (⇒) key to enter the Temperature sub-menu.



Press the (↓) key to scroll to the last category on the menu.

Press the (⇒) key to enter the Service sub-menu.



12.4.2 Main menu (only for models with a built-in gas mixer)

Press the (⇒) key to enter the menu.

You can exit the menu by pressing the (↑) key.



Temperature is the first category when you enter the menu.
Press the (⇒) key to enter the Temperature sub-menu.



Press the (↓) key to scroll further down in the menu.
Press the (⇒) key to enter the CO₂ sub-menu.



Press the (↓) key to scroll further down in the menu.
Press the (⇒) key to enter the O₂ sub-menu.



Press the (↓) key to scroll to the last category on the menu.
Press the (⇒) key to enter the Service sub-menu.



12.5 Sub-menus

12.5.1 Temperature sub-menu

Press the (⇒) key on the temperature menu to enter the temperature sub-menu.
Calibrate holding down the SP key and using (↑) and (↓) keys to adjust.



Move to the next sub-menu item with the (↓) key or one step up with the (↑) key.

Example - how to calibrate the temperature:

The temperature has to be measured with a suitable and calibrated device. With a quality thermometer, it has been determined that T1 is 37.4 °C. Locate “T1 CAL” in the sub-menu and press and hold the SP key. The display should show:



T1 37.0

Adjust the temperature by pressing the (↑) key 4 times while still holding the SP key down.

The display will show the steps from 37.1, 37.2, 37.3 and 37.4. When temperature equals the measured temperature, let go of the SP key. The value is stored and the temperature sensor for the T1 area has been modified.

 **Calibration procedure is the same for T1 - T12.**

12.5.2 CO₂ sub-menu (only for models with a built-in gas mixer)

Press the (⇒) key on the CO₂ menu to enter the CO₂ sub-menu.

The first item in the CO₂ sub-menu is CO₂ sensor calibration:



CO2CAL

Calibrate CO₂ by holding down the SP key and using (↑) and (↓) keys to adjust. Move to the next CO₂ sub-menu item with (↓) key or one step up with (↑) key.



CO2REG

Toggle CO₂ regulation on/off by holding the SP key and pressing (↑) or (↓) keys.

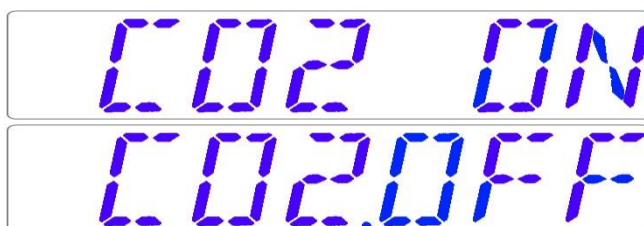

CO2 ON
CO2OFF

 **The default status for the CO₂ control is OFF.**

Move to the next CO₂ sub-menu item with (↓) key or one step up with (↑) key.
CO₂ flow rate is shown (it cannot be adjusted):



It shows the amount of CO₂ gas put into the system while regulating. The volume is shown in liters/hour. It usually will fluctuate along with the CO₂ regulation.

Press the (↓) key to move to the next item in the CO₂ sub-menu. CO₂ internal pressure rate is shown (it cannot be adjusted on the incubator. It is adjusted on the external gas regulator):



The value is in bar and it must be 0.4 – 0.6 bar (5.80 – 8.70 PSI) at all times.

Example – how to calibrate CO₂:

CO₂ gas concentration has to be measured with a suitable and calibrated device. The real CO₂ concentration has been determined to be 5.4% on the gas sample port.

Locate “CO₂ CAL” in the CO₂ sub-menu and press the SP key. The display will show:



Adjust the calibration to the desired level by pressing (↑) or (↓) keys. In this case, we want to adjust to 5.4%. Press (↑) key 4 times. The display will show 5.0, 5.1, 5.2, 5.3 and 5.4. When CO₂ equals measured CO₂, let go of the SP key. The value is stored and the CO₂ sensor calibration has been modified.

👉 **Pure CO₂ 100% gas recovery till 5% is less than 4 minutes.**

👉 **Calibration is done by adjusting the CO₂ level according to a measurement taken from the gas sampling outlet, using a precision CO₂ measurement device only.**

 **Calibration values should only be changed based on measurements taken by a trained user or technician.**

12.5.3 O₂ sub-menu (only for models with a built-in gas mixer)

Press the (⇒) key on O₂ to enter the O₂ sub-menu.

The first item in the O₂ sub-menu is O₂ sensor calibration:



O2CAL

Calibrate O₂ by holding down the SP key and using (↑) and (↓) keys to adjust. Move to the next O₂ sub-menu item with (↓) key or one step up with (↑) key.



O2REG

Toggle O₂ regulation on/off by holding the SP key and pressing (↑) or (↓) keys.



O2OFF
O2 ON

 **The Default status for the O₂ control is OFF.**

Move to the next O₂ sub-menu item with (↓) key or one step up with (↑) key.

N₂ flow rate is shown (it cannot be adjusted):



FLOW 10

It shows the amount of N₂ gas put into the system while regulating. The volume is shown in liters/hour. It usually will fluctuate along with the O₂ regulation.

Press (↓) key to move to the next item in the O₂ sub-menu.

O₂ internal pressure rate is shown (it cannot be adjusted on the incubator. It is adjusted

on the external gas regulator):



The value is in bar and it must be 0.4 – 0.6 bar (5.80 – 8.70 PSI) at all times.

Example – how to calibrate the O₂:

O₂ gas concentration has to be measured with a suitable and calibrated device. The real O₂ concentration has been determined to be 5.3% on the gas sample port.

Locate “O₂ CAL” in the O₂ sub-menu and press the SP key. The display will show:



Adjust the calibration to the desired level by pressing (↑) or (↓) keys. In this case, we want to adjust to 5.3%. Press (↑) key 3 times. The display will show 5.0, 5.1, 5.2 and 5.3. When O₂ equals measured O₂, let go of the SP key. The value is stored and the O₂ sensor calibration has been modified.

 **Calibration is done by adjusting the O₂ level according to a measurement taken from the gas sampling outlet, using a precision O₂ measurement device only.**

 **Calibration values should only be changed based on measurements taken by a trained user or technician.**

12.5.4 Service sub-menu

Press the (⇒) key on the service menu to enter the service sub-menu.

The service sub-menu is locked as default. The display will show:



Press (⇒) key and hold it for about 10 sec. Then the display will show the currently installed firmware version:



Ver 2.0 is only shown as an example. Consult Esco Medical or the local representative for the number of the latest version.

Move to the next service sub-menu item with (↓) key or one step up with (↑) key.

If the Multi-zone ART Workstation has a built-in gas mixer, there will be a “GAS” function under the service sub-menu. The display will show:



Press the (⇒) key to enter and press (↓) or (↑) keys to choose “PREMIX” or “CO₂/N₂”. Press the SP key and by pressing (↓) or (↑) keys, select “PREMIX” or “CO₂/N₂” gas mode. Let go of the SP key and the selected mode is now stored.

👉 When using the premixed gas mode in the Multi-zone ART Workstation model with a built-in gas mixer, it is necessary to use a premixed gas with higher gradation than the setpoint. For example, if you need to achieve a 5% CO₂ gas setpoint, premixed gas should have 7% CO₂ in its mixture.

Press (↑) to exit back into the menu.

13 Alarms

The display will show a red “A” and the affected parameter's status message on a single fault condition. An audio signal can be muted by pressing the alarm key once (toggled on/off for 5-minutes). There will be a red arrow that indicates if the alarm is triggered due to too high or too low values, and the audio on/off key will blink red:



Figure 13.1 Alarm key which indicates the alarm condition

The audio pattern is 3 short beeps followed by a 3-second pause. All alarms have the same audio pattern.

13.1 Temperature alarms

All 12 heating zones can trigger a temperature alarm if their temperature varies over ± 0.5 °C from the setpoint.

 **Remember that changing the setpoint to more than ± 0.5 °C from the current temperature will result in an alarm. The same goes for all calibration adjustments.**

The number will indicate the zone triggering the alarm following “A”.

Temperature is too high in compartment 3:



Temperature is too low in compartment 1:



The display will lock on the alarm condition and will stop alternating between the standard status messages. If the mute key is pressed, the display will shift to normal status and show the parameters for 5 minutes until the audio alarm comes back on again. The mute alarm key will still show the alarm condition by blinking red while the alarm is muted.

The zone layout and sensor placement are described in the section “15 Surface temperatures and measuring temperature”.

If a temperature sensor malfunctions, it will be indicated by the following warning:

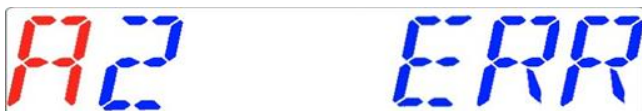

It denotes that the sensor in compartment 2 has failed. As a safety precaution, the heating of the affected area will be switched off.

13.2 Gas level alarms (only for models with a built-in gas mixer)

13.2.1 CO₂ alarms

The CO₂ gas level alarm is activated if the concentration of the CO₂ gas deviates more than $\pm 1\%$ from the setpoint.

 **Remember that changing the setpoint more than $\pm 1\%$ from the current gas level will result in a gas level alarm. The same goes for all calibration adjustments.**

CO₂ gas % is too low:



CO₂ gas % is too high:



The display will lock on the alarm condition and will stop alternating between the standard status messages. If the mute key is pressed, the display will shift to normal status and show the parameters for 5 minutes until the audio alarm comes back on again. The mute alarm key will still show the alarm condition by blinking red while the alarm is muted.

13.2.2 O₂ alarms

The O₂ gas level alarm is activated if the concentration of the O₂ gas deviates more than $\pm 1\%$ from the setpoint.

 **Remember that changing the setpoint more than $\pm 1\%$ from the current gas level will result in a gas level alarm. The same goes for all calibration adjustments.**

O₂ % is too low:



O₂ % is too high:



The display will lock on the alarm condition and will stop alternating between the standard status messages. If the mute key is pressed, the display will shift to normal status and show the parameters for 5 minutes until the audio alarm comes back on again. The mute alarm key will still show the alarm condition by blinking red while the alarm is muted.

13.3 Gas pressure alarms

13.3.1 CO₂ pressure alarm

If the CO₂ gas supply is not attached correctly or incorrect CO₂ gas pressure is applied to the system, Multi-zone ART Workstation will go into CO₂ pressure alarm mode. The display will show “CO2 P”, which indicates an incorrect incoming gas pressure. If the pressure falls below 0.3 bar (4.40 PSI) or rises above 0.7 bar (10.20 PSI), it will trigger the alarm.



 “P” stands for pressure.

The display will lock on the alarm condition and will stop alternating between the standard status messages. If the mute key is pressed, the display will shift to normal status and show the parameters for 5 minutes until the audio alarm comes back on again. The mute alarm key will still show the alarm condition by blinking red while the alarm is muted.

13.3.2 N₂ pressure alarm (only for models with built-in gas mixer)

If the N₂ gas supply is not attached correctly or incorrect N₂ gas pressure is applied to the system, Multi-zone ART Workstation will go into N₂ pressure alarm mode. The display will show “N2 P”, which indicates an incorrect incoming gas pressure. If the pressure falls below 0.3 bar (4.40 PSI) or rises above 0.7 bar (10.20 PSI), it will trigger the alarm.



👉 “P” stands for pressure.

The display will lock on the alarm condition and will stop alternating between the standard status messages. If the mute key is pressed, the display will shift to normal status and show the parameters for 5 minutes until the audio alarm comes back on again. The mute alarm key will still show the alarm condition by blinking red while the alarm is muted.

13.4 Multiple alarms

When there are two or more alarms, the display will indicate this by showing first “A MULTI” and then the alarm conditions:



The flow will be forced according to the alarms. The temperature alarms have 1st priority, gas level alarms 2nd, and pressure 3rd.

14 Changing the setpoints and heated mode

14.1 Temperature setpoint

The temperature setpoint can be adjusted in the range from 25 °C to 40.0 °C.

👉 The default temperature setpoint is 37.0 °C.

To change the temperature setpoint, follow these instructions:

1. When the display shows the current temperature:



2. Hold down the SP key and use (↑) and (↓) keys to adjust the setpoint: one keypress corresponds to a 0.1 change.
3. After changing the temperature, let go of the SP key. The value is now stored.

If the display does not show the current temperature reading, the (⇌) key will toggle between temperature, gas flow setpoint and heated mode.

14.2 Gas flow setpoint (only for models without a built-in gas mixer)

The gas flow setpoint can be adjusted in the range from 0 l/h to 40 l/h.

To change the gas flow setpoint, follow these instructions:

1. When the display shows the current gas flow:



2. Hold down the SP key and use (↑) and (↓) keys to adjust the setpoint: one keypress corresponds to a 1 l/h change.
3. After changing the temperature, let go of the SP key. The value is now stored.

If the display does not show the current gas flow setpoint reading, the (⇒) key will toggle between temperature, gas flow setpoint and heated mode.

14.3 CO₂ gas concentration setpoint (only for models with a built-in gas mixer)

The CO₂ concentration can be adjusted in the range between 3.0% to 10%.

 **The default CO₂ setpoint is 5.0%.**

To change the CO₂ concentration setpoint, follow these instructions:

1. When the display shows the CO₂ gas concentration:



2. Hold down the SP key and use (↑) and (↓) keys to adjust the setpoint: one keypress corresponds to a 0.1 change.
3. After changing the temperature, let go of the SP key. The value is now stored.

If the display does not show the current CO₂ reading, the (⇒) key will toggle between the temperature, CO₂, O₂ and heated mode readings.

14.4 O₂ gas concentration setpoint (only for models with a built-in gas mixer)

The O₂ concentration can be adjusted in the range between 5.0% to 20.0%.

 The default O₂ setpoint is 5.0%.

To change the O₂ concentration setpoint, follow these instructions:

1. When the display shows the O₂ concentration:



2. Hold down the SP key and use (↑) and (↓) keys to adjust the setpoint: one keypress corresponds to a 0.1 change.
3. After changing the temperature, let go of the SP key. The value is now stored.

If the display does not show the current O₂ reading, the (⇔) key will toggle between the temperature, CO₂, O₂ and heated mode readings.

14.5 Heated Mode

The table plate has 4 heated modes.

To change heated mode, follow these instructions:

1. When the display shows the current heated mode:



2. Hold down the SP key and use (↑) and (↓) keys to adjust the heated mode.
3. After changing the temperature, let go of the SP key. The mode is now stored.

Mode 1:

All zones are “ON” and controlled. The zones are heated up to the temperature setpoint.

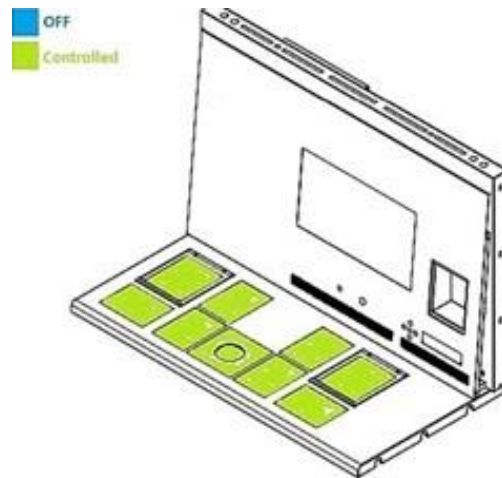

Figure 14.1 Mode 1

Mode 2:

Both compartments are “ON” and controlled.

The left side and the middle zone are “ON” and controlled.

The right side of the area is “OFF”; as shown in the picture below, all other zones are heated up to the temperature setpoint.

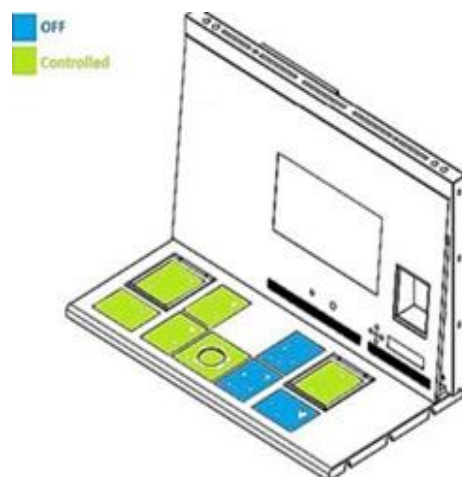

Figure 14.2 Mode 2

Mode 3:

Both compartments and the left side of the table plate are “ON” and controlled.

The middle zone and right-side area are “OFF”, as shown in the picture below.

All other zones are heated up to the temperature setpoint.

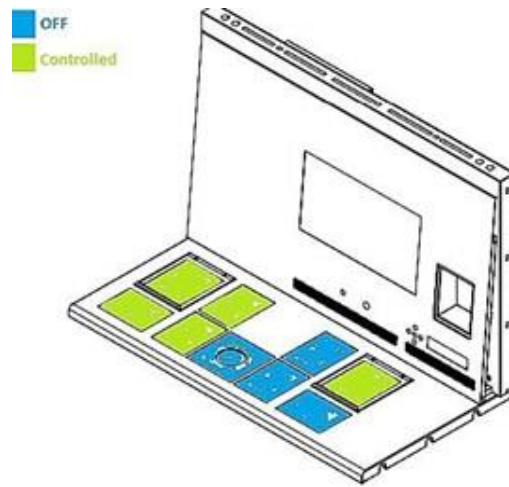

Figure 14.3 Mode 3

Mode 4:

Both compartments are “ON” and controlled.

The rest of the table plate is “OFF,” as shown in the picture below.

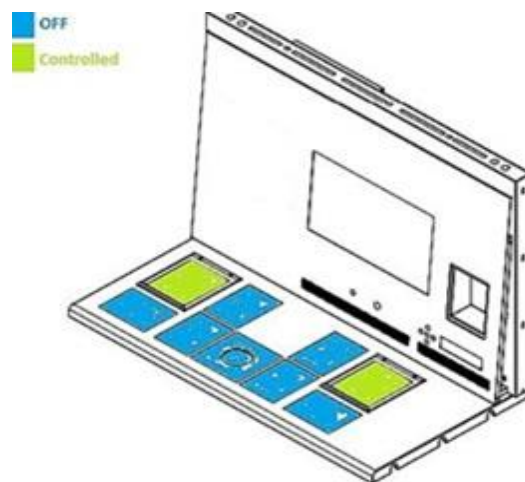

Figure 14.4 Mode 4

15 Surface temperatures and measuring temperature

In this section, the Multi-zone ART Workstation temperature controls system is described in more detail.

Multi-zone ART Workstation is equipped with 12 completely separate PID controllers for temperature measurement. Each controller is responsible for controlling the

temperature of a separate area.

Each of the 12 available areas is equipped with a separate temperature sensor and heater, allowing the user to adjust the temperature in every area separately, thus achieving higher precision.

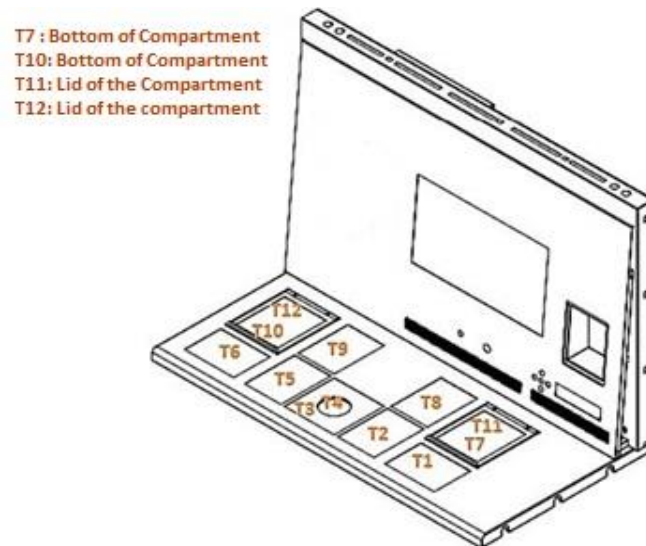

Figure 15.1 PID controllers on the table plate

Each area can be calibrated separately, using the item corresponding to the respective area in the menu. These items are placed in the menu and they are named: T1 CAL, T2 CAL, T3 CAL, T4 CAL, T5 CAL, T6 CAL, T7 CAL, T8 CAL, T9 CAL, T10 CAL, T11 CAL and T12 CAL.

To calibrate the temperature in a particular area, please find the corresponding sensor name and adjust it according to a measurement taken using a high-precision thermometer.

Esco Medical recommends only a suitable and calibrated device with a precision of at least 0.1 °C.

⚠ Temperature calibration is done by adjusting the Tx (where x is the sensor number) according to a measurement done on the spot relevant to the dish placement.

⚠ After temperature adjustment, give it at least 15 minutes for the temperature to stabilize, use the thermometer to verify the correct temperature on each area.

👉 Tape the calibrated thermometer sensor to the middle of the zone. It may be

necessary to do iterations before the zone is thoroughly calibrated.

👉 Heating modes do not affect the compartments.

Be careful when changing the calibration settings – make sure that only the altered value corresponds to where the measurement is done. Give the system time to adjust.

👉 There is no crossover heating between the 12 zones when adjusted to temperatures within 0.5 °C. At more considerable temperature differences, the hotter zone will affect the colder zone.

Note: how to calibrate the temperature at the T1 area can be found in this manual's 12.5.1 section.

16 Firmware

The firmware installed on your Multi-zone ART Workstation is upgradeable. Whenever a critical update is available, it will be provided to our distributors around the world – they will make sure that your incubator runs with the newest available firmware. A service technician can do this during the scheduled annual service.

Please follow these steps to check the firmware which is currently installed on your unit:

1. In the menu, locate the Service sub-menu “Serv” and press the (⇒) key to enter. The service sub-menu is locked as default. The display will show “LOCKED” and after pressing the (⇒) key and hold it for 10 sec, the display will show the currently installed firmware version:

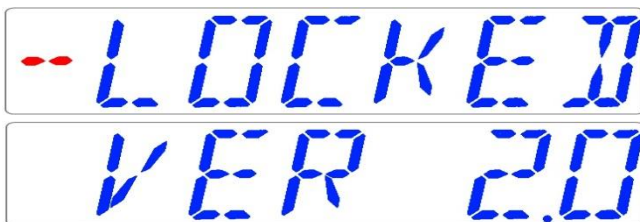

Ver 2.0 is only shown as an example. The current 4-ft Multi-zone ART Workstation with a built-in gas mixer firmware version is 3.0.3; 6-ft DUAL Multi-zone ART Workstation with a built-in gas mixer: the right side – 3.0.5 and left sides 3.0.1; all Multi-zone ART Workstations without a built-in gas mixer (premix only) – 3.0.4.

2. Press the (↑) key to exit back into the sub-menu.

17 The Laminar Flow

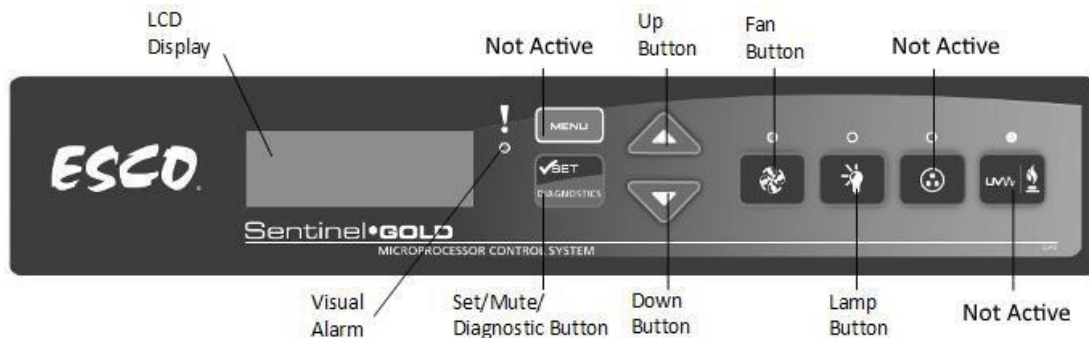

Figure 17.1 Main keys

- “Fan” button – turns on and turns off the fan. It activates standby mode.
- “Lamp” button – turns on and turns off the fluorescent lamps.
- “Socket” button – not active for the user.
- “UV/Gas” button – not active for the user.
- “Menu” button – enters the menu. It works like the “Back” button as well.
- “Set/Mute/Diagnostic” button – select folder/enter the parameter button.
- “UP/Down” buttons – scroll through the menu.

Only 3 functions are available for the user: switching “ON/OFF” the laminar airflow, activating the standby flow mode and switching “ON/OFF” the interior light.

18 Re-Certification by Service Personnel

Esco products generally provide years of trouble-free operation; however, they require maintenance and service like all equipment. Maintenance and service should be carried out by trained personnel. Esco offers training courses to equip service providers with the latest skills, information, and tools to maintain and service Esco products successfully. For more information on the nearest training course, please get in touch with Esco.

Service providers should familiarize themselves with the basic operating principles of products before working on them. Suitable references include information in the User Section of this Manual or brochures.

The Multi-zone ART Workstation generally require:

- Re-certification, when:
 - The workstation is re-located
 - Clean bench performance is suspected
 - After filter or blower replacement
 - At least once a year

During recertification:

- Workstation airflow velocities and flow patterns are verified against the manufacturer's specifications and relevant international standards
 - Filters are scan-tested to ensure they do not leak
 - Operator comfort tests may be performed
 - If airflow velocities are off setpoint, adjustments are made as part of the certification process before final values are recorded
- Airflow alarm calibration, when:
 - The cause of the airflow alarm cannot be determined
 - Re-certification indicates the displayed airflow deviates by $>0.02\text{m/s}$ (4fpm) from actually measured velocities (only for products with airflow velocity displays)
 - Filter replacement, when:
 - The filters are clogged, and the fan(s) are already adjusted to the maximum setting
 - Filter leaks that cannot be repaired are found during scan-testing
 - Fan replacement (typically rare) if a failure occurs
 - Routine maintenance also includes:
 - Fluorescent lamp(s) replacement - typically once every 2 years

18.1 Cabinet Field Calibration

Cabinet field certification must be performed on:

- New installation
- Relocation of cabinet
- Activation of airflow alarm with undetermined cause
- When cabinet performance is suspected
- At least once in a year or based on your risk assessment

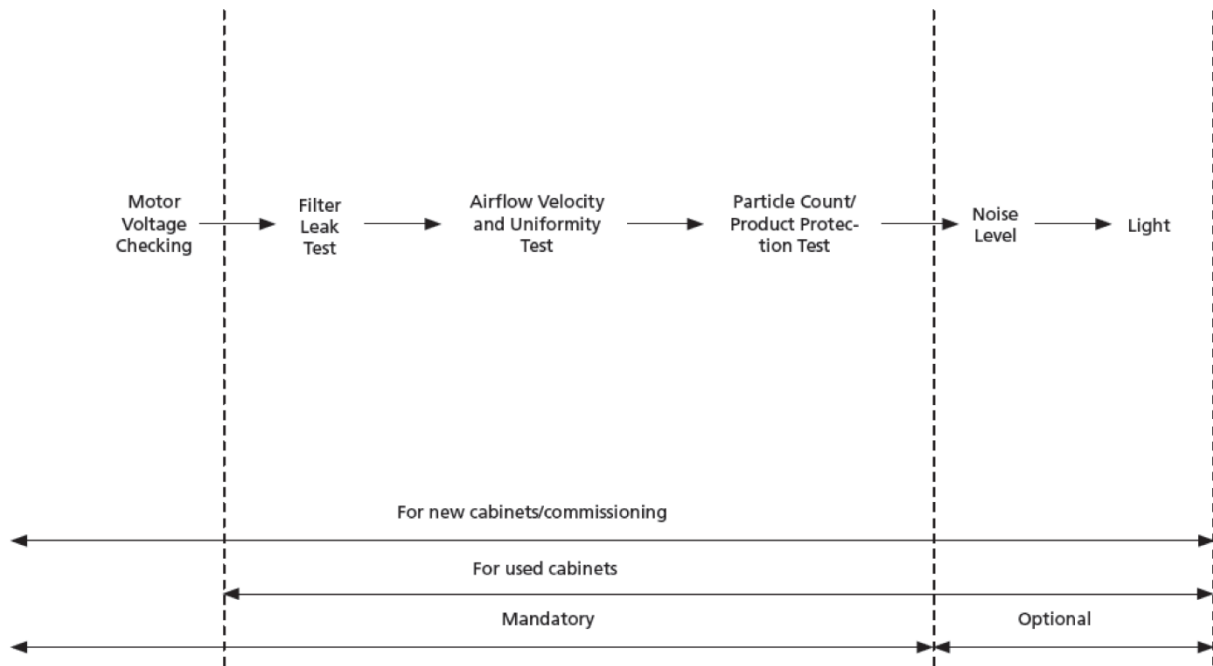

Figure 18.1 Steps on how to perform field certification

18.2 Performing Certification

18.2.1 Setting Cabinet in Maintenance Mode

To start the certification, ensure the fan and lamps are turned on. The cabinet should then be put to maintenance mode. In Maintenance Mode, all alarms are defeated, and the window can be moved without the light being switched off.

How to turn on the Maintenance Mode

1. Press the MENU button. Enter ADMIN PIN (default ADMIN PIN is 0009)
2. If SETTINGS is displayed, the ADMIN code has been removed, proceed to step 3
 - a. Press SET with 0 flashing
 - b. Press SET with 00 last digit flashing
 - c. Press SET with 000 last digit flashing
 - d. Press SET with 0000 last digit flashing
 - e. Press the “▼” button to key in 9
 - f. Press SET
3. The alarm will sound; wait until the alarm stops. The cabinet should read:

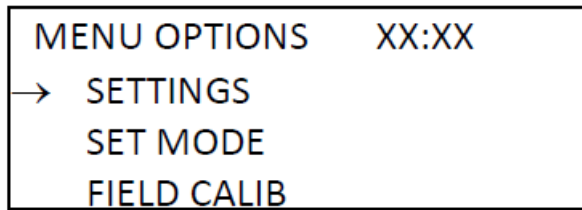

Figure 18.2 Menu options view in the cabinet

4. Use the “▼” button until the LCDs SET MODE. Press the SET button, and LCD would show:

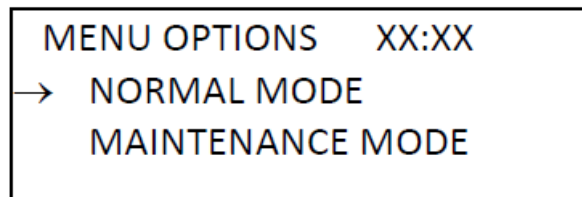

Figure 18.3 The LCD SET MODE view in the cabinet

5. Use the “▼” button until the LCDs MAINTENANCE message at the top line of the LCD. Press the SET button. The cabinet is now in maintenance mode, and the word “Maintenance” will blink continuously to indicate unsafe conditions.
6. Press the MENU button twice to exit from the menu tree.
7. The word “Maintenance” is displayed on the LCD, as shown below.

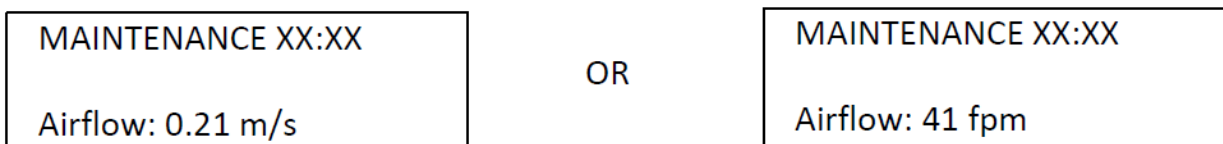



Figure 18.4 Maintenance mode message is ON

18.2.2 Locating the Speed Controller

The user needs to prepare for certification by locating the speed controller to change the motor speed.

1. Remove the pre-filter and mesh on top of the cabinet.
2. The ECMS speed control is located inside.
3. For a new cabinet installation, turn the speed controller required to get the same duty cycle as recorded in the factory. For annual re-certification or after the filter has been changed, adjust the motor duty cycle to get the target airflow, stated in the Airflow Velocity Test below.

 **Please cycle unit of measurement, whether metric or imperial, on each item**

testing.

18.2.3 Nominal Airflow Velocity and Uniformity Test

 The blower should be turned ON for 10 minutes before setting the airflow.

Put the Thermo anemometer on a plane that is 150 mm from the filter face, and measure the airflow using the grid below:

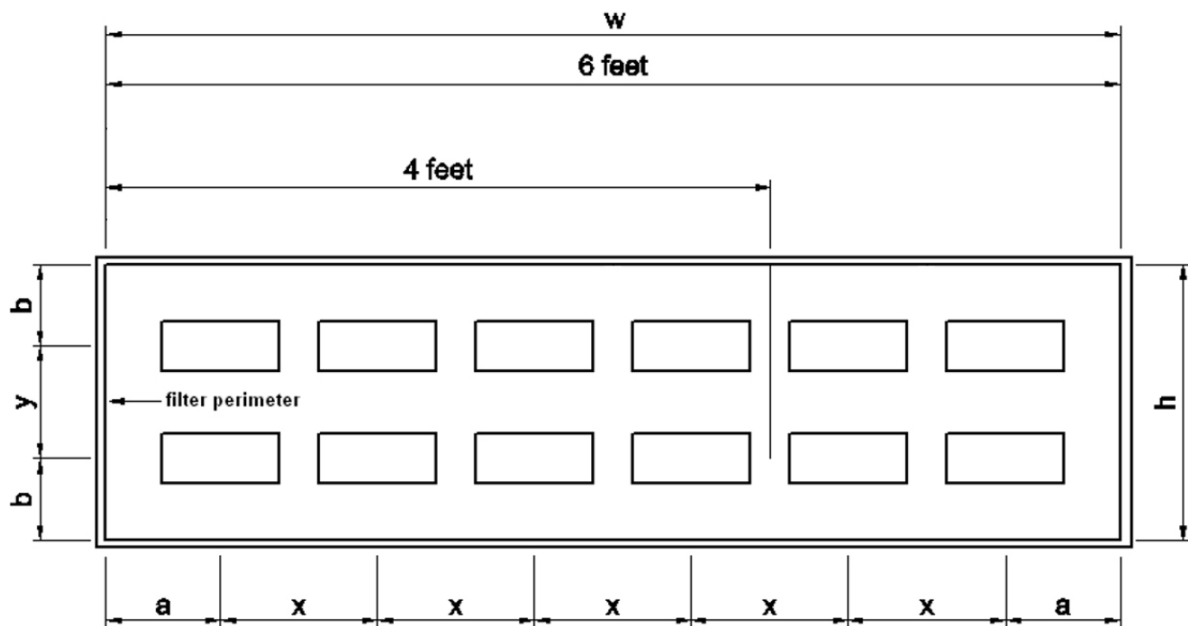

Figure 18.5 Airflow measuring grid

The airflow Grid Plane is 150 mm in front of the filter.

Table 18.1 Airflow grid plane distances in Multi-zone ART Workstation

| | Cabinet Model | Multi-zone ART Workstation 4 ft | Multi-zone ART Workstation 6 ft |
|----------------------|-------------------------------------|---------------------------------|---------------------------------|
| Left to Right | Distance from walls = a (mm) | 170.5 | 170.5 |
| | Distance apart = x (mm) | 306 | 307 |
| Front to Back | Distance from walls = b (mm) | 171.5 | 171.5 |
| | Distance apart = y (mm) | 157 | 157 |

Average Velocity: _____ m/s (fpm)

Maximum Deviation: _____ %

Acceptance Criteria: Average filter face velocity of 0.21 ± 0.02 m/s with no single value deviating more than 20% from the calculated average.

Testing was performed following the following IEST (Institute of Environmental Sciences and Technology) contamination control document: IEST-RP-CC002.2 “Recommended Practice for Uni-directional Flow Clean Air Devices” Section 6.1.

18.2.4 Particle Count Test

Use a particle counter with a sampling rate of 1 ft³ of air per minute. Put the particle counter sampling cone inside the work zone, following the grid below:

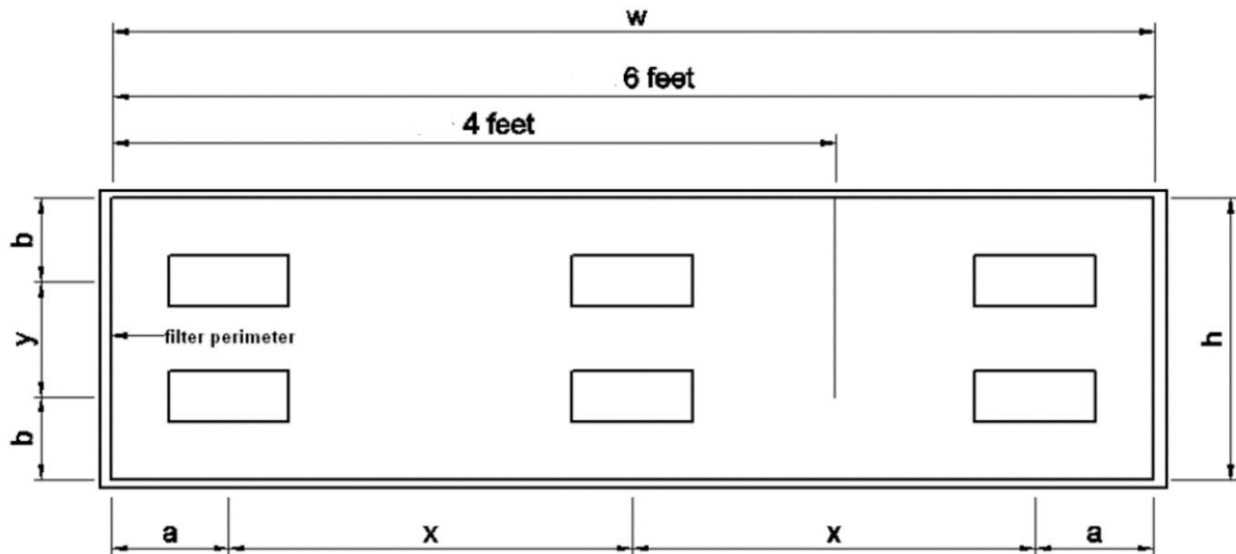

Figure 18.6 Particle counter sampling grid

The plane is 300 mm on the work surface.

Table 18.2 Particle counter sampling grid plane distances in Multi-zone ART Workstation

| | Cabinet Model | Multi-zone ART Workstation 4 ft | Multi-zone ART Workstation 6 ft |
|----------------------|-------------------------------------|---------------------------------|---------------------------------|
| Left to Right | Distance from walls = a (mm) | 170.5 | 170.5 |
| | Distance apart = x (mm) | 919 | 767 |
| Front to Back | Distance from walls = b (mm) | 171.5 | 171.5 |
| | Distance apart = y (mm) | 157 | 157 |

Average Count: _____ for particle size of 0.5 micron and larger samples in 0.028 m³ (1 ft³) of air

Note: The particle count done in the factory is in “as-built” condition. If a 0.5 micron counter is used on the field, there shall be no more than one particle of 0.5 μm samples in 1 m³ (35.3 ft³) of air to reach ISO Class 3.

Cleanliness rating: ISO Class 3 per ISO 14644.1 (≤ 35 counts for particles equal to and larger than 0.5 μm samples in 1 m³ (35.3 ft³) of air).

Results: **Pass / Fail**

18.2.5 Heated Zones Temperature Test

With the cabinet running for more than 30 minutes, use a calibrated thermometer and probe to measure the temperature. Tape the temperature probe at the center of each heated work zone and/or heated glass stage as indicated by the drawing below. Stabilize

for 5 mins before taking measurement. If there's a departure with the measurement, follow the procedure in 12.5.1. After calibrating, measure the temperature again.

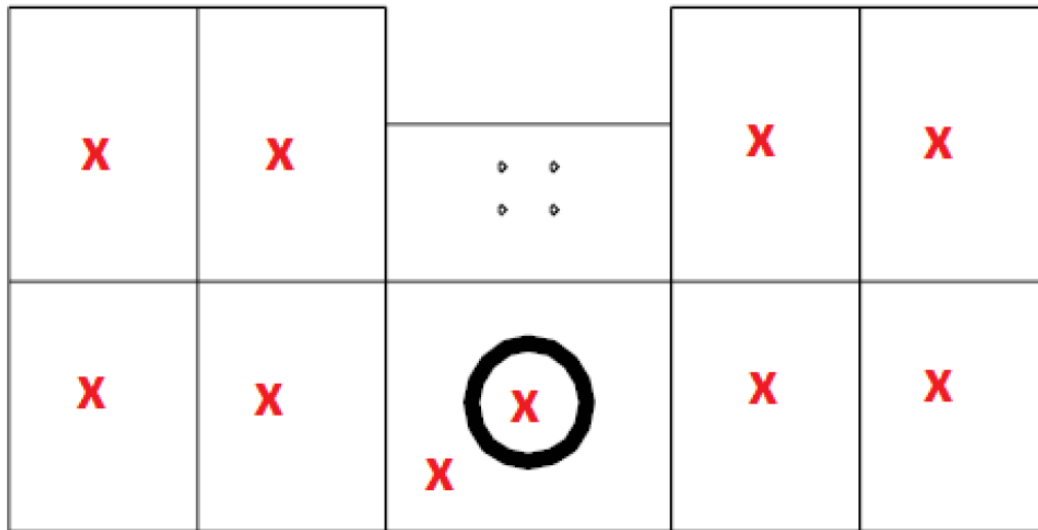

Figure 18.7 Heating zones in Multi-zone ART Workstation

Acceptance: Temperature within ± 0.1 of the setpoint
 Result: **Pass / Fail**

18.2.6 Noise Level Test (Optional for field testing)

With the cabinet running under regular parameters, obtain the noise level of the cabinet during normal operation using a calibrated noise level meter at 300 mm in front of the work surface area lower edge and 380 mm above the recessed work surface area.

Acceptance: Maximum corrected noise level of 67 dBA (Based on NSF/ANSI 49 standard).
 Result: Pass / Fail
 Disclaimer: 1. This noise test was done in the factory susceptible to reflective, reverberant, and background noise effects. This noise figure may be different than the brochure value that is obtained from the anechoic chamber.
 2. If the difference between cabinet and ambient noise was less than 10 dBA, a correction chart was used, which, combined with transient ambient noise, may vary the corrected noise level by ± 1.5 dBA.

The test was performed following the following IEST (Institute of Environmental Sciences and Technology) contamination control document: IEST-RP-CC002.2 "Recommended Practice for Unidirectional Flow Clean Air Devices" Section 6.11.

18.2.7 Light Intensity Test (Optional for field testing)

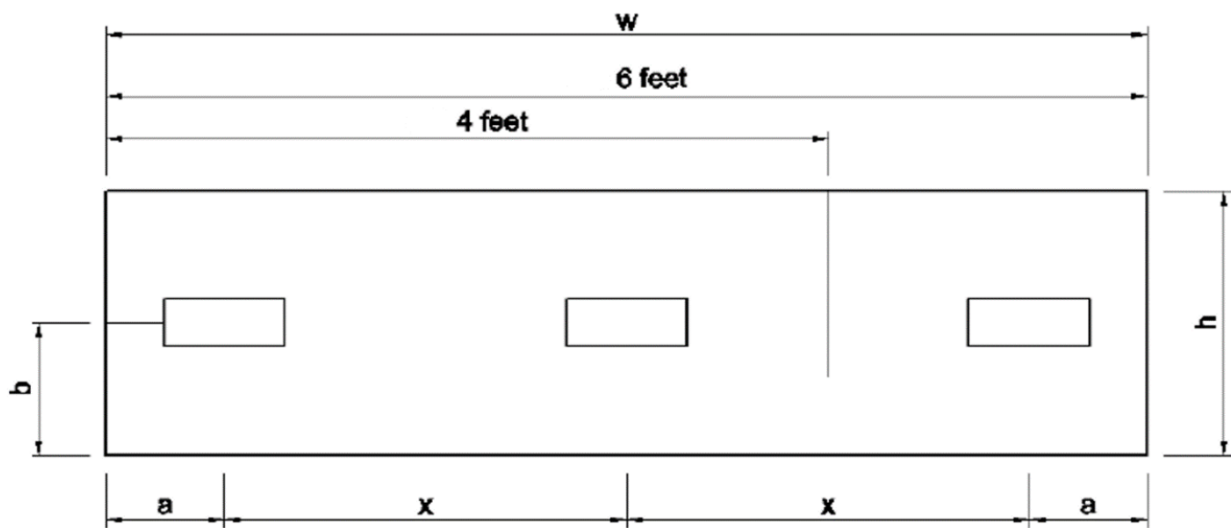

Figure 18.8 Light intensity testing grid

A light intensity meter was used to measure light intensity at the front to back centerline work surface level of the cabinet.

Table 18.3 Light intensity testing distances in Multi-zone ART Workstation

| | Cabinet Model | Multi-zone ART Workstation 4 ft | Multi-zone ART Workstation 6 ft |
|----------------------|-------------------------------------|---------------------------------|---------------------------------|
| Left to Right | Distance from walls = a (mm) | 170.5 | 170.5 |
| | Distance apart = x (mm) | 919 | 767 |
| Front to Back | Distance from walls = b (mm) | 171.5 | 171.5 |

Average light reading: _____ lux (ft-candles)

Acceptance criteria: _____ Average light reading should be at least 800 lux (74 ft-candles)

Results: **Pass / Fail**

18.3 Calibration of Sentinel™ Gold Control

 Calibration is only necessary when the air velocity display is inaccurate or faulty alarm setpoints need to be corrected.

The purpose of calibrating the controller is to let the controller record particular output voltages from the airflow sensor and correspond them to fail and nominal points of air velocity. Once the calibration has been completed, the control will show the air velocity whenever the fan is in operation.

All Esco cabinets are factory-tested and calibrated before being shipped.

Calibrating the Airflow Nomina Setpoint – 0.21 ± 0.02 m/s (41 fpm):

- Press the MENU button. If the cabinet is in Maintenance Mode, no PIN will be asked. If the cabinet is in Normal Mode, enter PIN 0009. Press the ▼ button until the display shows “FIELD CALIB”, then press SET.
- The pointer will be at “AirFlow Calib”. Press the SET button.
- A “Read Manual” message is shown to discourage an unauthorized person. Press SET to continue.
- Ensure that the Nominal Airflow Setpoint is 0.21 ± 0.02 m/s. The airflow volume is blinking, indicating that it can be changed. Select your obtained Airflow using ▲ and ▼ buttons. Press the SET button to continue.
- Wait for 3 minutes for the software to record this sensor ADC point. Do not change Motor Duty Cycle or disrupt airflow/ sensor during this time.
- After the 3-minute countdown has been completed, a beep will sound, and then the display shows “CALIBRATION DONE”. The screen will go back to the MENU options shown in Step 2.
- Return the cabinet from Maintenance Mode to Normal Mode.

 **If the Calibration Error message is displayed, please ensure that airflow is within ± 0.02 m/s from nominal and repeat the calibration.**

18.4 Replacement of filter

Filter replacement

1. Remove the polycarbonate cover, which is held in position by screws M4 in front and thumbscrews at the back.
2. Remove the airflow sensor, which is held in position by screws M4.

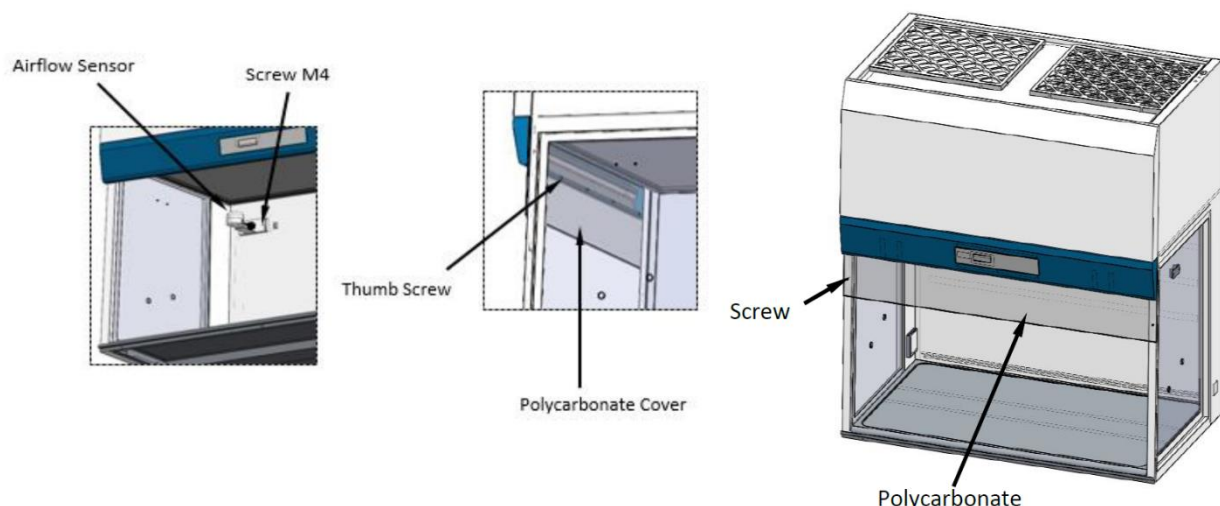

Figure 18.9 Airflow Sensor removal

Supply Filter Removal

3. Remove the Hexagon Bold M8 screw and then the Clamp Filter. Carefully remove the ULPA filter.

4. Replace the new filter. Reverse the above steps for the assembly.

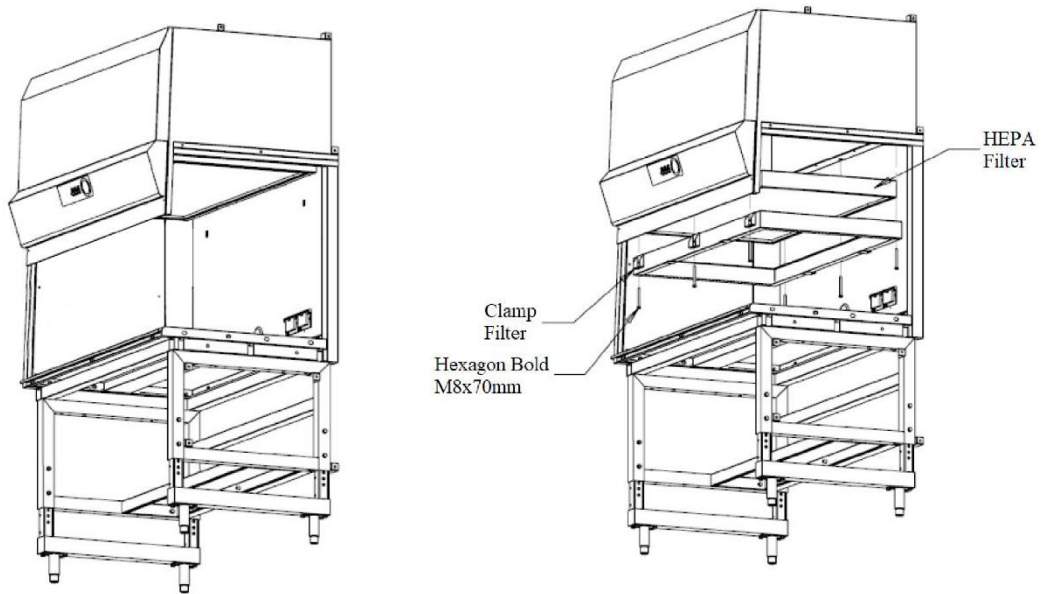

Figure 18.10 Supply filter removal

The nuts used to clamp the filter must be tightened until 50% compressed with an alternating pattern after the new filter is installed. The nuts must be equally tightened to give uniform compression. It is to prevent over-compression on one side of the filter that can cause filter leakage.

The nut tightening pattern is shown below:

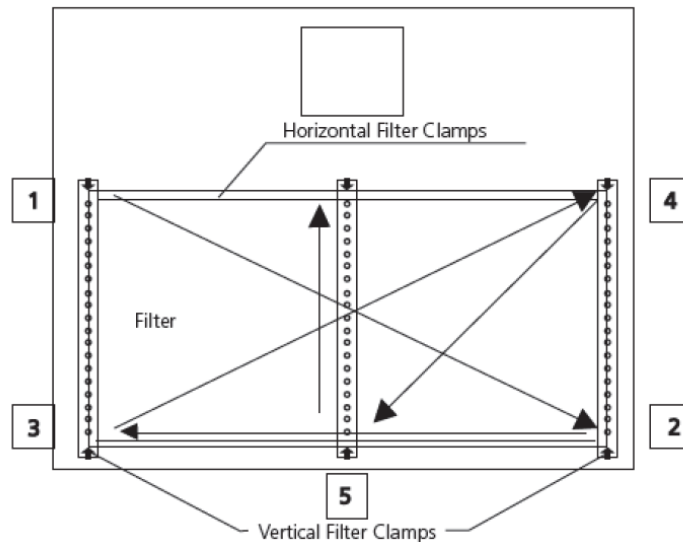

Figure 18.11 Nut tightening pattern

18.5 Replacement of blower

1. Pre-filter and mesh must be removed first before proceeding to the blower replacement instruction. Disconnect electrical connections as necessary to free the blower.
2. Remove the nuts, which clamp the blower. Pull out and lift the blower carefully.
3. Replace the new blower by reversing the above steps.

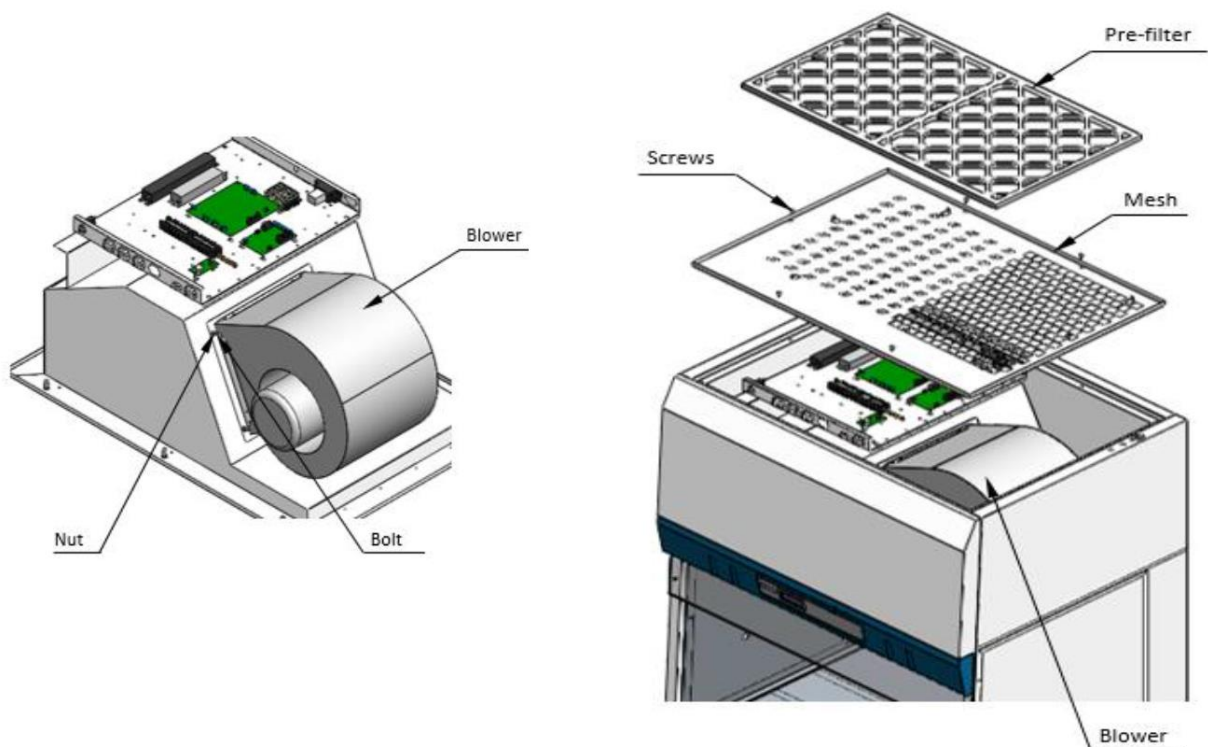

Figure 18.12 Blower replacement scheme

18.6 Replacement of fluorescent lamp and UV lamp

18.6.1 Replacement of Fluorescent Lamp

- Before changing the fluorescent bulbs, ensure that the clean bench is powered down and disconnected from the electrical supply
- Locate the bulbs
- Remove the power clips at the ends of the bulbs by gently pulling while holding the bulb steady
- Remove the bulbs from the mounting clips and replace them with new ones
- Replace the power clips on the ends of the new bulbs and ensure they are firmly seated
- Reconnect the clean bench to the electrical supply and test the bulbs for proper operation

18.6.2 Replacement of UV Lamp

- Disconnect the electrical connections
- Take out the old UV lamp by rotating 90° counter-clockwise and pull downward
- Install the new UV lamp by pushing it upward and rotate 90° clockwise

19 Cleaning instructions

19.1 Considerations about a sterile device

Multi-zone ART Workstation is not a sterile device. It is not delivered sterile state and it is not possible to keep them sterile while in use.

However, their design was created with great care to make it easy for the user to keep the device sufficiently clean and not contaminate the key components.

These cleaning instructions are for general-purpose use and have not been validated for sufficiency to cover all possible usage aspects and all imaginable use scenarios.

The design features intended to provide cleanliness are:

- A ULPA filtered laminar airflow
- A flush stainless-steel work surface
- Use of parts that withstand cleaning well

19.2 Manufacturer recommended cleaning procedure

 **Always validate the cleaning procedures locally; for more guidance, consult your manufacturer or the distributor.**

The routine cleaning procedure is recommended for regular processing and maintenance. The combination of standard cleaning procedures and disinfection procedures is recommended for event-related concerns such as media spills, visual accumulation of soil and/or other evidence of contamination. It is also recommended to clean and disinfect Multi-zone ART Workstation immediately after any media spills.

Periodic cleaning of the device (with no embryos inside)

Wearing gloves and good handling techniques are essential to successful cleaning.

1. Power off the Multi-zone ART Workstation (underside panel).
2. It is recommended that the unit is cleaned with aqueous 70% isopropyl alcohol: moisten a sterile wipe and clean all internal and external surfaces of the device by rubbing the wipe on the surfaces.

3. Following cleaning, leave the compartment's lids (in Multi-zone ART Workstation with compartments) open to allow sufficient time to ensure that all alcohol fumes have dissipated.
4. Finally, purified or sterile water is used to wipe the device surfaces.
5. Inspect the device: if visually clean, the device is ready for use.
6. Turn on the Multi-zone ART Workstation (underside panel).

If the device is not visually clean, repeat the process from step 2.

19.3 Manufacturer recommended disinfection procedure

Disinfection of the device (with no embryos inside)

The use of gloves and good handling techniques are essential for successful disinfection.

Proceed with the following steps (this procedure has been demonstrated during the on-site training program as part of the installation protocol):

1. Power off the Multi-zone ART Workstation (underside panel).
2. Open the lids (in Multi-zone ART Workstation with compartments).
3. Use the required disinfectant to disinfect the internal surface and a glass plate on the lid's top. Use sterile wipes to apply the disinfectant.
4. Wipe all internal surfaces and the top of the lid with three wipes at least. Repeat until the wipes are not discolored.
5. Change your gloves, and after 10 minutes of contact time, spray sterile water on the surfaces and wipe them with a sterile wipe.
6. Inspect the device – if it is visually clean, consider it ready for use. If the device is visually not clean, go to step 3 and repeat the procedure.
7. Turn on the Multi-zone ART Workstation (underside panel).

20 Heat optimization plates

The Carry Tray heat optimization plate will ensure full contact with the dish. It generally means much more stable temperature conditions for the cells. The plate fits the area under the gas hood. The plate can be taken out for cleaning and serves as a convenient way to carry several dishes between the CO₂ incubator and the Multi-zone ART Workstation.



Do not use autoclave at the inserts. It will damage the inserts as high temperature bends them out of shape.

Place the dish where it fits the pattern. There are Carry Tray heat optimization plates for Nunc® or Falcon® dishes.

👉 Use only the correct type of Carry Tray heat optimization plates for your dishes.



Figure 20.1 Carry Tray

21 Humidification

If the Multi-zone ART Workstation is used for open culture conditions, humidification and gas hood are recommended.

If the Multi-zone ART Workstation is used for culture with a mineral overlay, it is unnecessary to use the humidification system.

The Multi-zone ART Workstation design does not allow active control of humidity levels in circulated gas. Though the humidification method used in the Multi-zone ART Workstation increase circulating gas humidity which will decrease evaporation risk in media of Petri dishes placed in compartment. Usually expected humidification level in the Multi-zone ART Workstation compartments would maintain 70-77%.

👉 One-third of the humidification bottle should be filled with sterile water for the Multi-zone ART Workstation to work properly and maintain the required humidity in the system.

👉 Water in the humidification bottle must be changed at least once per week.

22 Temperature validation

The single 4ft Multi-zone ART Workstation has 5 PT-1000 Class B sensors, whereas the dual 6ft Multi-zone ART Workstation – 9 PT-1000 Class B sensors. 5 sensors are on the left side of the table plate and 4 are on the table plate's right side.

Each zone has an extra sensor for validation (zone 1, 2, 3, 5, 6). These sensors are not connected to any of the electronics on the unit. The user can connect an external device to validate the temperature readings.

PT-1000 Class B sensors are located in the central positions of the bottom zones and are connected to a connector inside of the table plate as shown:

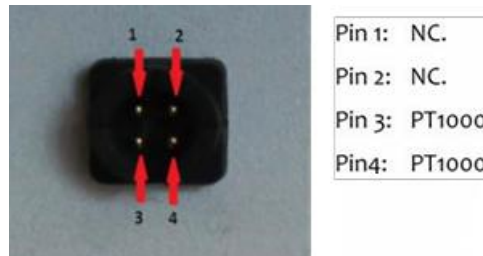

Figure 22.1 Pin

Esco Medical or your distributor can supply a connector and wire.

The zones' temperature conditions can be logged continually externally through the connectors without compromising the unit's performance. Any logging system that uses standard PT-1000 sensors can be used.

Esco Medical can supply an external logging system for the sensors.

23 All in one PC

The single Multi-zone ART Workstation is equipped with one powerful touch-enabled AIO PC, whereas dual Multi-zone ART Workstation – 2 AIO PCs. Switch “ON/OFF” the PC by pressing the button below the screen.



Figure 23.1 The AIO PC screen in Multi-zone ART Workstation

First, the PC will start and load the Windows operating system. The workstation logger surveillance software will automatically generate parameters, and warnings will be shown on the screen.

23.1 Data Logger Software

Under normal working conditions, on the PC display, the user should see numeric values.

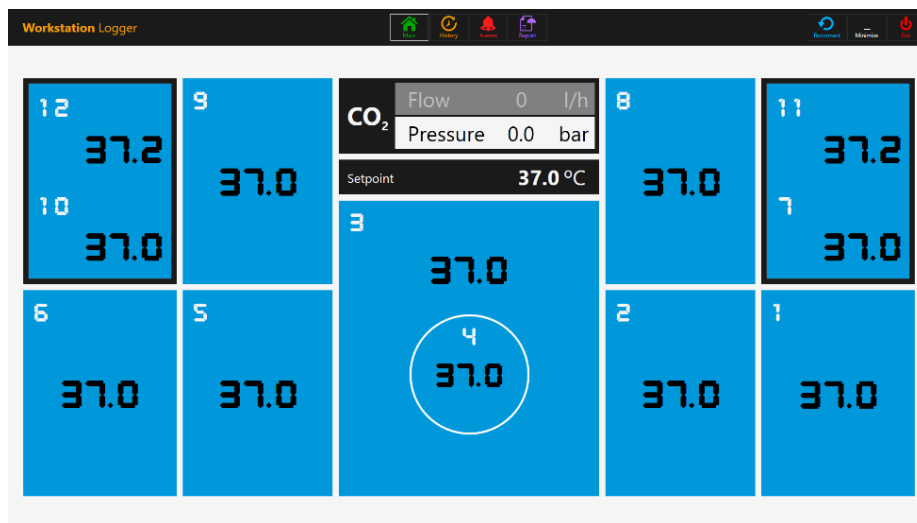

Figure 23.2 The Workstation Logger view under normal working conditions (without a gas mixer)

For Multi-zone ART Workstation models with a built-in gas mixer, the main display also shows CO₂ level, CO₂ flow, CO₂ pressure, O₂ level, N₂ flow, N₂ pressure, CO₂ and O₂ setpoints and both active gas mode (mix or premix) and culture mode (under oil culture or open culture).

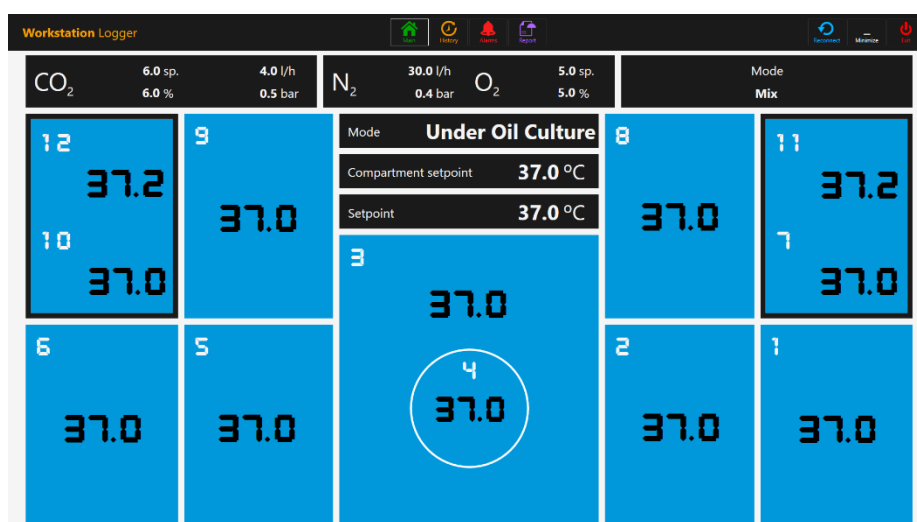

Figure 23.3 The Workstation Logger view under normal working conditions (with a gas mixer)

There is also a second display, with only shows culture mode, compartment setpoint and temperature setpoint.

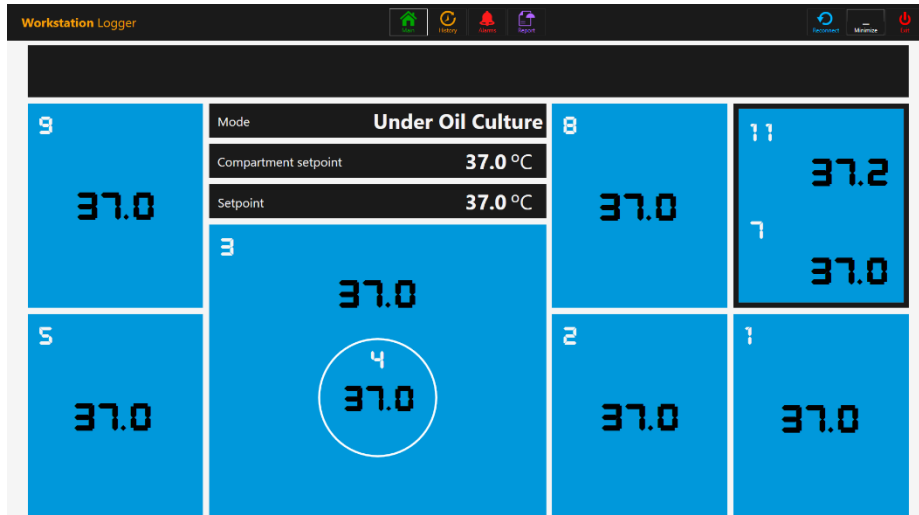

Figure 23.4 The Workstation Logger 2nd display view under normal working conditions (with a gas mixer)

If the signal is lost, dotted lines will appear instead of numeric values.



Figure 23.5 The Workstation Logger main view when the signal is lost

Once the signal is established, numeric values will be shown.

The blue color signifies that the zone is in normal operation mode. If there is an alarm, the color will shift to red on the relevant zone.

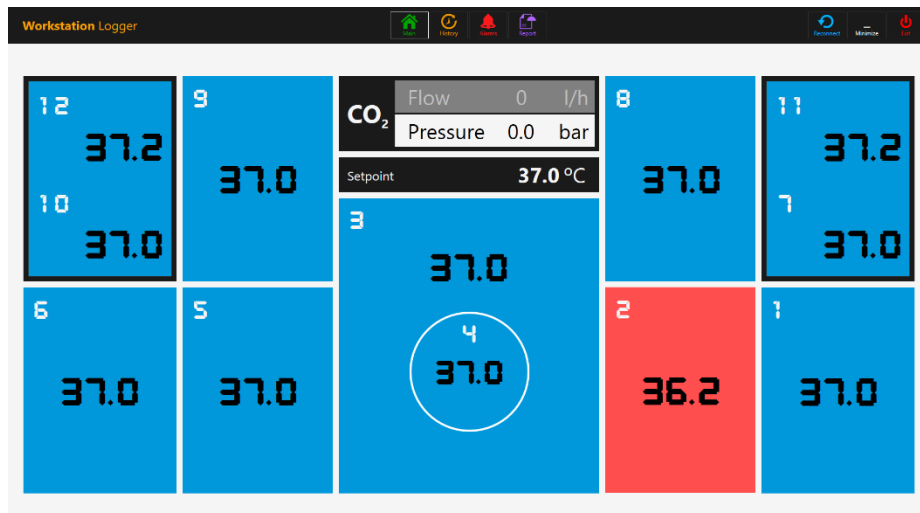

Figure 23.6 The Workstation Logger main view when there is a low-temperature alarm in the T2 area

In this way, the user will always have a clear visual indication of the regular operation and an easy way to identify and respond to a malfunction.

👍 This is a unique safety feature of the Multi-zone ART workstation, which cannot be found on any comparable system.

Some models of Multi-zone Workstations contain compartments. In this case, the zone will have a black border and two temperature values (bottom and lid).

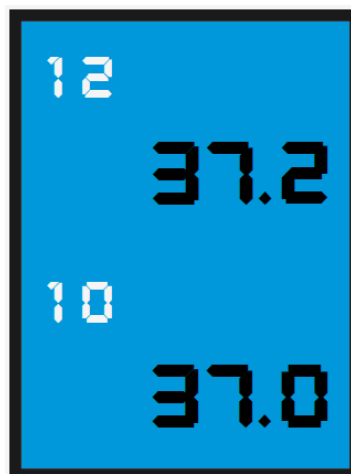

Figure 23.7 Compartment view in the Workstation Logger

At the top of the screen, 4 navigation buttons are placed in the middle and 3 actions buttons in the right-hand corner.

The “MAIN” button brings up the main view (shown in the 23.2 and 23.3 pictures above).

The “HISTORY” button toggles the graph view, where graphs can be shown for all the

parameters. It is useful for documentation of the stability of the system and to identify errant behavior.

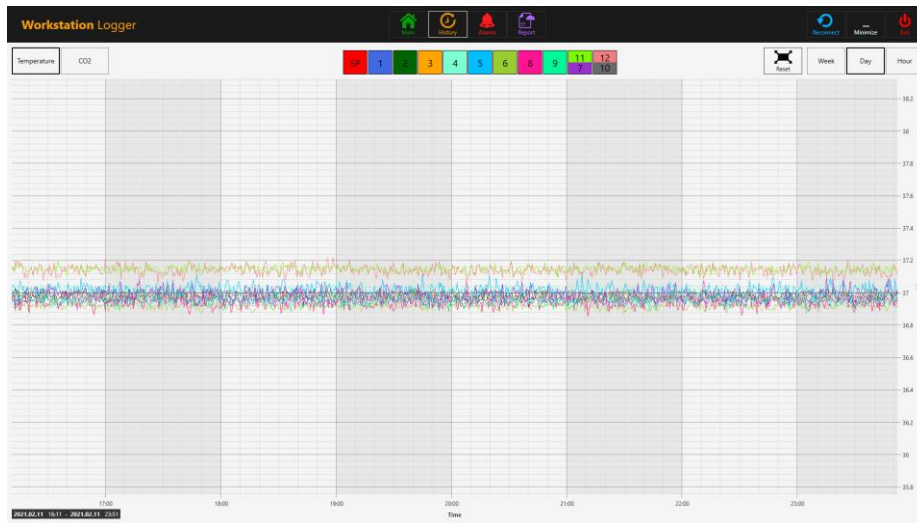

Figure 23.8 The “History” temperature data view

Several extra buttons appear in the graph view. By pressing the button with the number for the zone, the user can see temperatures and toggle “ON/OFF” graphs for each zone in the view.

For Multi-zone Workstation with compartments, the button will contain two values wherein two separate temperature curves will be shown.

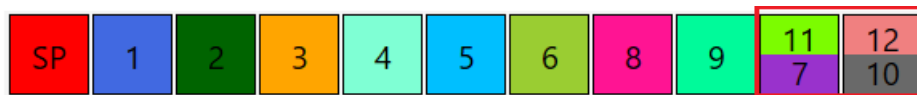

Figure 23.9 Compartment with two temperature values

A zoom function is available by touching the screen and swiping the finger left over the area that should be zoomed.

Pressing the “Reset” button will jump back to full view.

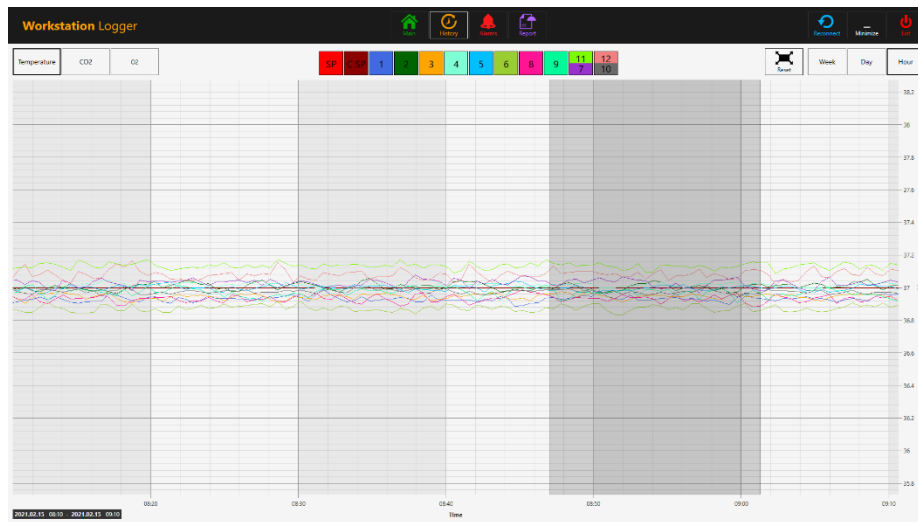

Figure 23.10 The zoom-in graph view

If there are data accumulated, it is possible to shift between a “Week”, “Day” and “Hour” view.

Pressing the CO₂ button will shift from the temperature data view to the CO₂ gas data view. In Multi-zone ART Workstation models without a built-in gas mixer, the user can only see the flow and pressure's historical CO₂ data.

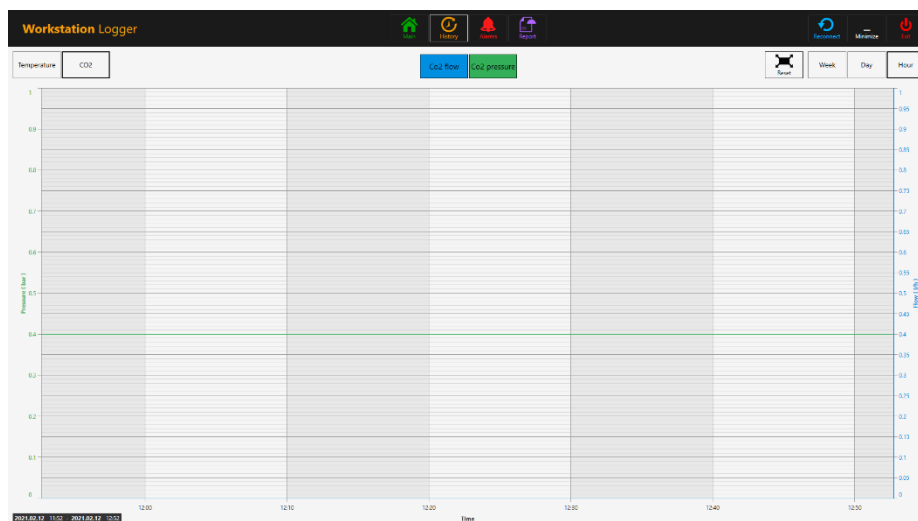

Figure 23.11 The “History” CO₂ data view

In Multi-zone ART Workstation models with a built-in gas mixer, the user can see the historical data of CO₂ gas concentration setpoint, concentration, flow and pressure.

Pressing the O₂ button will shift from the CO₂ gas data view to the O₂ gas data view. This function is only available in Multi-zone ART Workstation models with a built-in gas mixer.

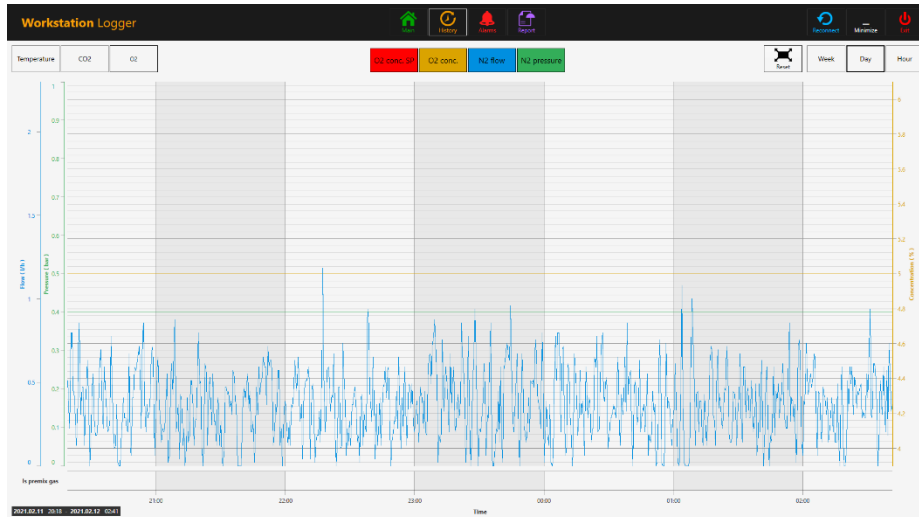

Figure 23.12 The “History” O₂ data view

The user can see historical data of O₂ gas concentration setpoint, concentration, N₂ gas flow and pressure.

The “Alarm” button will bring up the graphical alarm view. Alarm conditions for the parameters are shown as red on the timeline, thus making easy identification possible.

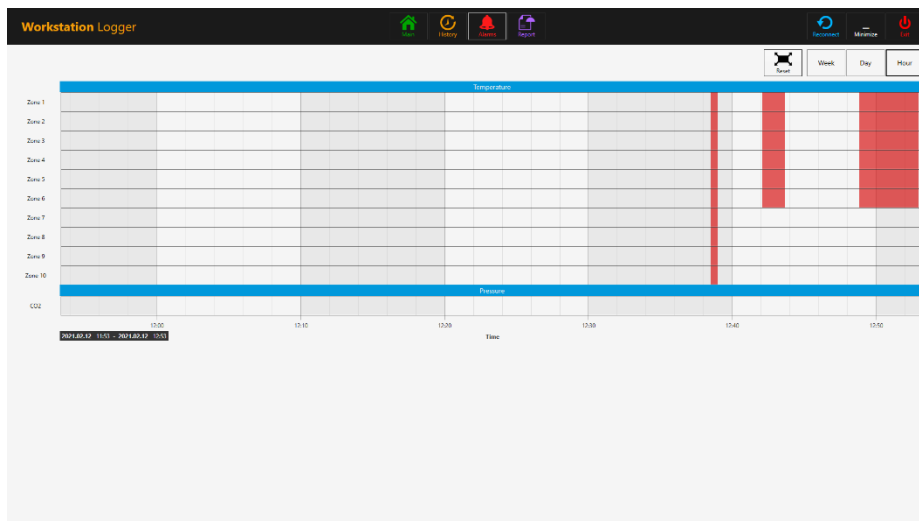

Figure 23.13 The graphical “Alarm” view (without a gas mixer)

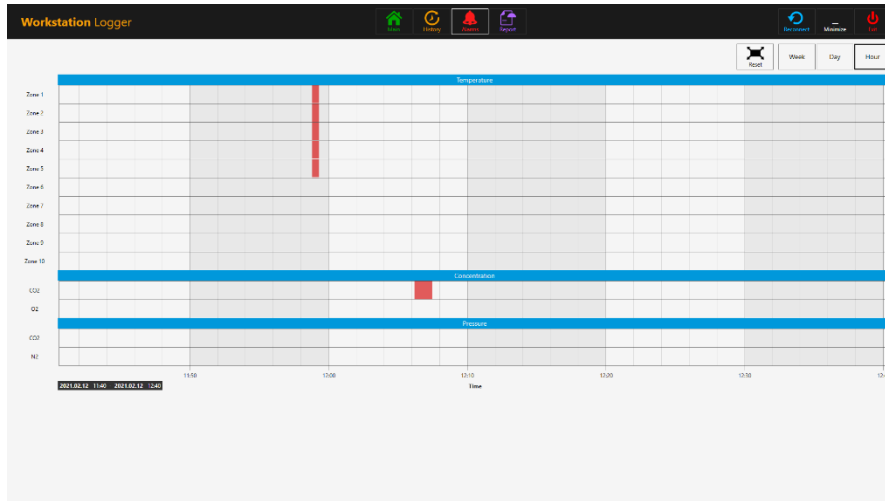

Figure 23.14 The graphical “Alarm” view (with a gas mixer)

The “Report” button will bring up the report mode. All the Multi-zone ART workstation's running parameters can easily be documented and printed as a report or exported in PDF, Excel or Word for convenient ISO quality management compliance.

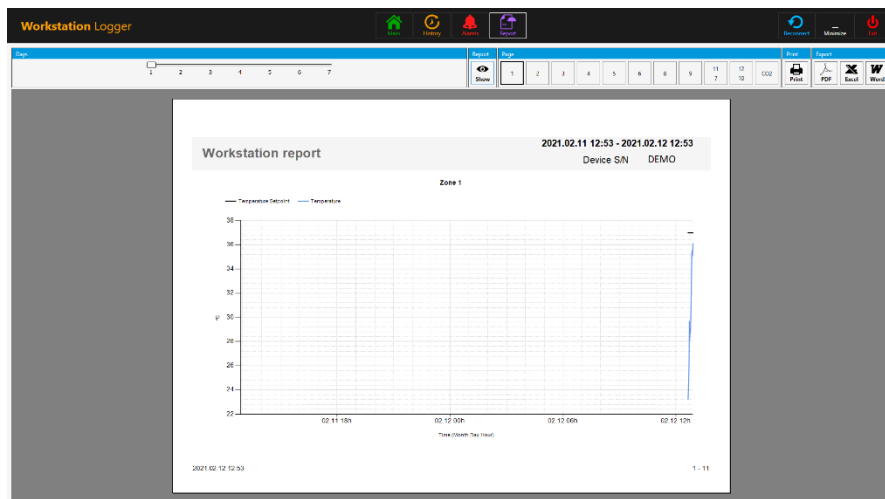

Figure 23.15 The “Report” mode view (without a gas mixer)

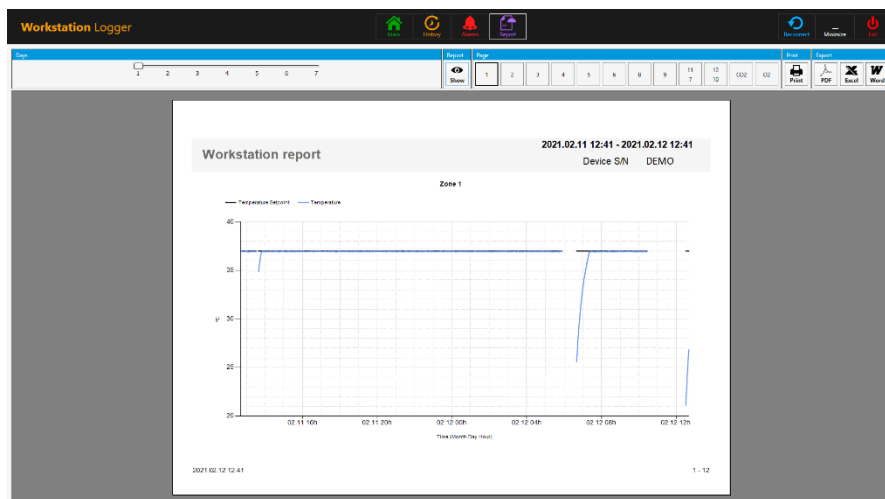

Figure 23.16 The “Report” mode view (with a gas mixer)

The 3 action buttons are located on the right-hand side:

- The “Reconnect” button allows the system to reconnect with the sensors (in case of data loss due to USB connection issues).
- The “Minimize” button toggles the full-screen format off for the Workstation Logger.
- The “Exit” button shuts down the Workstation Logger software.



No data will be stored and all safety surveillance functions will be operative if the Workstation Logger is shut down.

The AIO PC can easily be used to display an image from any USB-type microscope camera.

A standard USB socket is located under the humidification system. It can be used to load the microscope camera drivers or other software onto the AIO PC. When the software is set up, the microscope camera can be connected to the USB socket and the image shown on the screen.



A force function is built into the Workstation Logger. When the microscope camera image uses the full screen on the AIO PC, the system will visually alert the user to any alarm conditions and make a rapid shift to the Workstation Logger's full view possible.

24 Maintenance

The Multi-zone ART Workstation is designed to be easy to use, but the reliable and safe operation of this equipment is based on the following conditions:

1. Correct calibration of temperature and gas level, using high-precision equipment in the intervals prescribed based on clinical practice at the laboratory, where Multi-zone ART Workstation is used. The manufacturer recommends that the period between validation should be no longer than 14 days.
2. In-line HEPA filters must be replaced yearly during annual maintenance.
3. According to the clinical practice intervals, suitable cleaning is in the laboratory where Multi-zone ART Workstation is used. The manufacturer does not recommend periods longer than 14 days between cleaning.



It is essential to perform the inspection and service at the intervals indicated in the MAINTENANCE section below. Failure to do so can have serious adverse outcomes, causing the unit to stop performing as expected and cause damage to samples, patients or users.

 **Warranty is considered to be void if service and maintenance are not followed.**

 **Warranty is considered void if service and maintenance procedures are done not by trained and authorized personnel.**

25 Emergency Procedures

Total loss of power to or on the unit:

- Remove all the samples and place them in an alternative or backup device that is not affected by the problem
- The Multi-zone ART Workstation will lose its temperature below a safe level in around 5 minutes
- The CO₂ concentration will remain within 1% of the setpoint for 30 minutes if the lids remain closed

If a single temperature alarm goes off:

- Remove all the samples and place them in an alternative or backup device that is not affected by the problem
- The Multi-zone ART Workstation will lose its temperature below a safe level in around 5 minutes
- Remove the samples from the affected zone. They can be relocated to the other zones. Each zone is separate so that the other zones will stay safe

If multiple temperature alarms go off:

- Remove the samples from the affected zones. They can be relocated to either of the other zones. Each zone is separate so that the others will stay safe

If the CO₂ pressure alarm goes off:

- Inspect the external gas supply and the gas supply lines. If the problem is external and not readily amendable, it usually will not be necessary to perform any emergency procedures other than stop using the humidification system

26 User Troubleshooting

Table 26.1 Heating system

| Symptom | Cause | Action |
|--------------------------------|--|--|
| No heating, the display is off | The unit is switched off at the back or not connected to the power | Switch the device on or connect the power |
| No heating | The alarm is on | The temperature is more than 0.5 °C off the set temperature |
| | The setpoint for temperature is wrong | Check the desired temperature setpoint |
| Uneven heating | System not calibrated | Calibrate each zone according to the user manual, using a high precision thermometer |

Table 26.2 CO₂ gas regulator

| Symptom | Cause | Action |
|---|---|--|
| "CO ₂ P" is shown on the display | No/wrong CO ₂ gas pressure to the system | Check CO ₂ gas supply; make sure that pressure is kept stable between 0.4 - 0.6 bar (5.80 – 8.70 PSI) |

Table 26.3 Data Logger

| Symptom | Cause | Action |
|-----------------------|--|---|
| No data is sent to PC | System not powered | Check mains |
| | The system is on standby or switched off | Switch the system on |
| | The data cable between Incubator and PC not correctly attached | Check connection. Use only the cable supplied with the unit |
| | Data logger software/USB driver not correctly installed | Please refer to the software installation guide |

Table 26.4 Display

| Symptom | Cause | Action |
|-------------------------------|--------------------|--|
| Missing segment(s) in display | Failure in the PCB | Contact your Esco Medical Distributor to replace the PCB |

Table 26.5 Keyboard

| Symptom | Cause | Action |
|--|---------------------|---|
| The absent or erratic function of keys | Failure in the keys | Contact your Esco Medical Distributor to replace the keys |

27 Specifications

Table 27.1 Multi-zone ART Workstation general specifications

| Technical specifications | MAW-4D | MAW-6D MONO | MAW-6D DUAL | MAW-6D MP |
|--|---|---|--|--|
| Work area dimensions (WxDxH) | 1260 x 500 x 710 mm | 1870 x 500 x 710 mm | | 1870 x 490 x 780 mm |
| External dimensions without support stand (WxDxH) | 1340 x 640 x 1300 mm | 1950 x 640 x 1300 mm | | 1950 x 647 x 1360 mm |
| External dimension with "B" type support stand (WxDxH) | 1340 x 640 x 2160 mm | 1950 x 640 x 2160 mm | | 1950 x 647 x 2220 mm |
| Laminar airflow velocity | Average of 0,21 m/s or 41 fpm ($\pm 20\%$) | | | |
| Filter efficiency | >99.999% for particle size between 0.1 to 0.3 microns per IEST-RP-CC001.3 / H14 per EN 1822 | | | |
| Noise level (per NSF 49) | 47 dBA | 52 dBA | | |
| Per-filter | Disposable and non-washable polyester fibers with 85% arrestance, EU3 rated | | | |
| Heating system | Smart power injection electrical heating, (9+1) zones | Smart power injection electrical heating, 2 x (9+1) zones | | Smart power injection electrical heating, (9+1) zones |
| Temperature accuracy | $\pm 0.2\text{ }^{\circ}\text{C}$ | | | |
| Temperature uniformity | $\pm 0.2\text{ }^{\circ}\text{C}$ | | | |
| Included advanced features | <ul style="list-style-type: none"> • Integrated humidification system HS-1 • Surveillance system with data logger • AIO PC • Heated glass stage • Transmitted light source SC-1 (with bulb) • 5 x PT1000 validation ports | <ul style="list-style-type: none"> • Dual Integrated humidification system HS-1 • Surveillance system with data logger • AIO PC • 2 x Heated glass stage • 2 x Transmitted light source SC-1 (with bulb) • 10 x PT1000 validation ports | <ul style="list-style-type: none"> • Dual Integrated humidification system HS-1 • Surveillance system with data logger • AIO PC • Heated glass stage • Transmitted light source SC-1 (with bulb) • 5 x PT1000 validation ports | <ul style="list-style-type: none"> • Dual Integrated humidification system HS-1 • Surveillance system with data logger • AIO PC • Heated glass stage • Transmitted light source SC-1 (with bulb) • 5 x PT1000 validation ports |
| Included accessories | <ul style="list-style-type: none"> • 1 x water bottle for HS-1, including tubing • 1 x sample carry tray • 1 x humidified gas plastic cover | <ul style="list-style-type: none"> • 2 x water bottle for HS-1, including tubing • 2 x sample carry tray • 2 x humidified gas plastic cover | <ul style="list-style-type: none"> • 1 x water bottle for HS-1, including tubing • 1 x sample carry tray • 1 x humidified gas plastic cover | <ul style="list-style-type: none"> • 1 x water bottle for HS-1, including tubing • 1 x sample carry tray • 1 x humidified gas plastic cover |
| Microscope provision | Provision for 1 microscope | | Provision for 2 microscopes | Provision for 1 microscope and 1 inverted microscope |

Table 27.2 Multi-zone ART Workstation with MIRI® compartments general specifications

| Technical specifications | MAW-4D MC | MAW-6D MONO-MC | MAW-6D DUAL-MC | MAW-6D MP-MC |
|--|---|---|-------------------|--|
| Work area dimensions (WxDxH) | 1260 x 500 x 710 mm | 1870 x 500 x 710 mm | | 1870 x 490 x 780 mm |
| External dimensions without support stand (WxDxH) | 1340 x 640 x 1300 mm | 1950 x 640 x 1300 mm | | 1950 x 647 x 1360 mm |
| External dimension with “B” type support stand (WxDxH) | 1340 x 640 x 2160 mm | 1950 x 640 x 2160 mm | | 1950 x 647 x 2220 mm |
| Laminar airflow velocity | Average of 0,21 m/s or 41 fpm (± 20%) | | | |
| Filter efficiency | >99.999% for particle size between 0.1 to 0.3 microns per IEST-RP-CC001.3 / H14 per EN 1822 | | | |
| Noise level (As per IEST) | 47 dBA | 52 dBA | | |
| Per-filter | Disposable and non-washable polyester fibers with 85% arrestance, EU3 rated | | | |
| Heating system | Smart power injection electrical heating, (7+1) zones | Smart power injection electrical heating, 2 x (7+1) zones | | Smart power injection electrical heating, (7+1) zones |
| Number of MIRI® compartments | 2 | 3 | | 2 |
| Temperature accuracy | ± 0.2 °C | | | |
| Temperature uniformity | ± 0.2 °C | | | |
| Included advanced features | <ul style="list-style-type: none"> • Integrated humidification system HS-1 • Surveillance system with data logger • AIO PC • Heated glass stage • Transmitted light source SC-1 (with bulb) • 5 x PT1000 validation ports | <ul style="list-style-type: none"> • Dual Integrated humidification system HS-1 • Surveillance system with data logger • AIO PC • 2 x Heated glass stage • 2 x Transmitted light source SC-1 (with bulb) • 10 x PT1000 validation ports | | <ul style="list-style-type: none"> • Dual Integrated humidification system HS-1 • Surveillance system with data logger • AIO PC • Heated glass stage • Transmitted light source SC-1 (with bulb) • 5 x PT1000 validation ports |
| Included accessories | <ul style="list-style-type: none"> • 1 x water bottle for HS-1, including tubing • 2 x sample carry tray • 1 x humidified gas plastic cover | <ul style="list-style-type: none"> • 2 x water bottle for HS-1, including tubing • 3 x sample carry tray • 2 x humidified gas plastic cover | | <ul style="list-style-type: none"> • 1 x water bottle for HS-1, including tubing • 2 x sample carry tray • 1 x humidified gas plastic cover |
| Microscope provision | Provision for 1 microscope | Provision for 2 microscopes | | Provision for 1 microscope and 1 inverted microscope |

28 Electromagnetic compatibility

Table 28.1 Electromagnetic emissions

| Guidance and manufacturer's declaration – electromagnetic emissions | | |
|--|-------------------|--|
| The Multi-zone ART Workstation is intended for use in the electromagnetic environment specified below. The customer or the Multi-zone ART Workstation user should ensure that it is used in such an environment. | | |
| Emissions test | Compliance | Electromagnetic environment – guidance |
| RF emissions CISPR 11 | Group 1 | The Multi-zone ART Workstation does not use RF energy. Therefore, its RF emissions are very low and are not likely to cause any interference in nearby electronic equipment. |
| RF emissions CISPR 11 | Class A | The Multi-zone ART Workstation is suitable for use in a hospital environment. |
| Harmonic emissions IEC 61000-3-2 | Class A | |
| Voltage fluctuations/ flicker emissions | Class A | It is not for domestic establishments. |

Table 28.2 Electromagnetic immunity

| Guidance and manufacturer's declaration – electromagnetic immunity | | | |
|--|--|--------------------------------|---|
| The Multi-zone ART Workstation is intended for use in the electromagnetic environment specified below. The customer or the Multi-zone ART Workstation user should ensure that it is used in such an environment. | | | |
| Immunity test | IEC 60601 Test level | Compliance level | Electromagnetic environment-guidance |
| Electrostatic discharge (ESD) IEC 61000-4-2 | ±6 kV contact ±8 kV air | ±6 kV contact ±8 kV air | Floors should be wood, concrete or ceramic tile. If floors are covered with synthetic material, the relative humidity should be at least 30%. |
| Electrical fast transient/burst IEC 61000-4-4 | ±2 kV for power supply lines ±1 kV for input/output lines | | |
| Surge IEC 61000-4-5 | ±1kV differential mode ±2kV common mode | | |
| Voltage dips, short interruptions and voltage variations on power supply input lines IEC 61000-4-11 | <5 % 100V (>95% dip in 100V) for 0.5 cycle 40% 100V (60% dip in 100V) for 5 cycles 70% 100V (30% dip in 100V) for 25 cycles) dip in 100V) for 5 sec | | |
| Power frequency (50/60 Hz) magnetic field IEC 61000-4-8 | 3 A/m | Performance A | Power frequency magnetic fields should be at levels characteristic of a specific location in a typical commercial or hospital environment. |

Guidance and manufacturer's declaration – electromagnetic immunity

The Multi-zone ART Workstation is intended for use in the electromagnetic environment specified below. The customer or the Multi-zone ART Workstation user should ensure that it is used in such an environment.

| Immunity test | IEC 60601 Test level | Compliance level | Electromagnetic environment-guidance |
|--|--|------------------------------------|--|
| <p>Conducted RF IEC 61000-4-6</p> <p>Radiated RF IEC 61000-4-3</p> | <p>10 Vrms 150kHz to 80 MHz in ISM bands</p> <p>3V/m 80 MHz to 2.5 GHz</p> | <p>3 V/m from 80MHz to 2.5 GHz</p> | <p>Portable and mobile RF communications equipment should be used no closer to any part of the Multi-zone ART Workstation, including cables, than the recommended separation distance calculated from the equation applicable to the transmitter's frequency.</p> <p>Recommended separation distance</p> <p>$d=0.35 P$</p> <p>$d=0.35 P$ 80MHz to 800 MHz $d=0.7 P$ 800MHz to 2.5 GHz</p> <p>P is the maximum output power rating of the transmitter in watts (W) according to the transmitter manufacturer, <i>d</i> is the recommended separation distance in meters (m).</p> <p>As determined by an electromagnetic site survey, field strengths from fixed RF transmitters should be less than the compliance level in each frequency range.</p> <p>Interference may occur near equipment marked with.</p> |

Table 28.3 Recommended separation distances

Recommended separation distances between portable and mobile RF communication equipment and the Multi-zone ART Workstation

The Multi-zone ART Workstation is intended for use in the electromagnetic environment in which radiated RF disturbances are controlled. The customer or the Multi-zone ART Workstation user, can help prevent electromagnetic interference by maintaining a minimum distance between portable and mobile RF communications equipment (transmitters) and the Multi-zone ART Workstation as recommended below according to the maximum output power of the communications equipment.

| The rated maximum output power of the transmitter W | Separation distance according to the frequency of the transmitter (m) | | |
|--|---|--------------------------------------|---------------------------------------|
| | 150 kHz to 80 MHz $d=1.2\sqrt{P}$ | 80 MHz to 800 MHz $d=1.2\sqrt{P}$ | 800 MHz to 2.5 GHz $d=2.3\sqrt{P}$ |
| 0.01 | 0.1 m | 0.1 m | 0.2 m |
| 0.1 | 0.4 m | 0.4 m | 0.7 m |
| 1 | 1.2 m | 1.2 m | 2.3 m |
| 10 | 3.7 m | 3.7 m | 7.4 m |
| 100 | 11.7 m | 11.7 m | 23.3 m |

For transmitters rated at a maximum output power not listed above, the recommended separation distance d in meters (m) can be estimated using the equation applicable to the frequency of the transmitter, where P is the maximum output power rating of the transmitter in watts (w) according to the transmitter manufacturer.

NOTE 1: At 80 MHz and 800 MHz, the higher frequency range's separation distance applies.

NOTE 2: These guidelines may not apply in all situations.

Medical devices may be affected by cellular telephones and other personal or household devices not intended for medical facilities. It is recommended that all equipment used near the Multi-zone ART workstation product comply with the medical electromagnetic compatibility standard and to check before use that no interference is evident or possible. If interference is suspected or possible, switching off the offending device is the usual solution required in aircraft and medical facilities.

According to the EMC information, medical electrical equipment needs special precautions regarding EMC and needs to be installed and put into service. Portable and mobile RF communications equipment can affect medical electrical equipment.

29 The Validation guide

29.1 Product release criteria

The Esco Medical Multi-zone ART Workstation undergoes a strict quality and performance testing before being released for sale.

29.1.1 Performance

Each component used in the Multi-zone ART Workstation is tested during the manufacturing process to ensure a defect-free unit.

Before release, the Multi-zone ART Workstation is tested per a release test having a duration of at least 24 hours, using high-performance thermometers and gas analyzers, along with real-time data logging to ensure that the unit lives up to expected performance standards.

Pass I: Internal sensor temperature variation from setpoint within ± 0.1 °C absolute.

The below list is only applicable for Multi-zone ART Workstation with a built-in gas mixer

Pass II: Internal sensor CO₂ concentration variation from setpoint within $\pm 0.2\%$ absolute.

Pass III: Internal sensor N₂ concentration variation from setpoint within $\pm 0.2\%$ absolute.

Pass IV: Gas flow CO₂ less than 2 l/h

Pass V: Gas flow N₂ less than 8 l/h

29.1.2 Electrical safety

An electric safety test is also carried out using a high-performance medical safety tester with each unit to ensure that electric requirements for medical devices defined by the EN60601-1 3rd edition standards are met.

29.1.3 Communication & data logging

Each unit has a built-in AIO PC running the Multi-zone ART Workstation data logging software. Gas is supplied to the unit, and the system is activated. The data received by the PC program is analyzed to ensure communication between the Multi-zone ART Workstation and the PC.

29.1.4 Gas concentration levels and consumption (only for models with a built-in gas mixer)

A leak test is performed on each compartment. The maximum leakage allowed through the seals is 0.0 l/h.

The average CO₂ gas variation must stay within setpoint $\pm 0.2\%$ absolute on all external sampling and internal sensor readings.

The gas flow under regular operation is less than 2 liters per hour. The average should be below 2 liters.

The average N₂ gas variation must stay within SP $\pm 0.2\%$ absolute on all external sampling and internal sensor readings.

The gas flow under regular operation is less than 8 liters per hour. The average should be below 8 liters.

29.1.5 Communication & data logging

- No misalignment in the heated glass stage.
- Surface preparation of stainless-steel tabletop for visual indication of heated zones.
- No scratches or missing paint on the cabinet.
- Overall presentable as a high-quality item.

30 Validation on-site

Even though at Esco Medical, we strive to do the most comprehensive tests before the device is shipped to the customer, there is no way to be sure that everything is still OK at the location when the device is set up.

Therefore, in keeping with established good medical device practice, we have set up a validation test regimen that must be completed before the device can be accepted into clinical use.

In the following, we describe these tests and the equipment necessary to perform them.

A test documentation form is also provided. A copy must be provided to Esco Medical for internal device tracking and device history record.

30.1 Mandatory equipment

 **All equipment must be of high quality and calibrated.**

- A thermometer with a suitable sensor for measuring in a droplet of media covered with Paraffin oil with a resolution minimum of 0.1 °C
- A thermometer with a suitable sensor for measuring on an aluminum surface with

- a resolution minimum of 0.1 °C
- A Pressure tester with a range of 0.0 – 1.0 bar.
- A Multimeter.

Additional equipment only needed for Multi-zone ART Workstation with a built-in gas mixer:

- A CO₂ analyzer with a range of 0.0 – 10.0%.
- An O₂ analyzer with a range of 0.0 – 20.0%.

30.2 Recommended additional equipment

 **All equipment must be calibrated and of high quality.**

- A VOC meter able to measure the most common volatile organic compounds at least at the ppm level
- Particle counters can measure a laser particle counter that can sample a volume of 0.1 CFM and at least at the 0.3-micron particle size level.

Recommended additional equipment can be used for further installation testing that will minimize the likelihood of problems on-site.

31 Testing

31.1 Gas supply premixed CO₂/O₂

 **Multi-zone ART Workstation, without a built-in gas mixer, can only use premixed CO₂/O₂ gas. Multi-zone ART Workstation, with a built-in gas mixer, can use either premixed CO₂/O₂ or pure CO₂ and O₂ gas.**

A humidified gassing system is provided to avoid evaporation and maintain a safe pH level in open culture bicarbonate buffered culture media while working in the Multi-zone ART Workstation.

If the media is covered with oil, the humidification part of the gassing system can be omitted, but the gas part is still essential to keep the pH levels safe.

 **If a HEPES buffered culture media is used, the gas system must not be utilized.**

The gassing system must be connected to a premixed gas supply at around 0.4 – 0.6 bar pressure. The gas mixture, for example, can be 5.0% CO₂, 5.0% O₂ and 90% N₂ or whatever mixture that is suitable for the type of media used.

Connect the gas bottle and adjust the pressure. Fill up the humidification bottle with sterile water and connect the tubes. Put the gas hood on the tabletop over the gas outlet. Measure the CO₂ concentration with a gas analyzer inside the gas hood.

PASS: CO₂ concentration measured must correspond to the Premixed gas.

 **The use of premixed CO₂/O₂ gas with moisture will damage the flow sensors. Moisture level must be verified on the gas manufacturer's certificate: only 0.0 ppm v/v Max is permissible.**

31.2 Gas supply CO₂ (only for models with a built-in gas mixer)

For the regulation system to maintain the correct CO₂ concentration level in the Multi-zone ART Workstation MIRI® compartments, the device must be connected to a stable source of 100% CO₂ at 0.4 – 0.6 bar (5.80 – 8.70 PSI) of pressure.

Measure the CO₂ concentration in the gas supply by routing the gas line into a bottle without a lid and a suitably large opening. Set the pressure/flow so that the bottle is flushed continually with gas, without increasing pressure in the bottle (i.e., the amount of gas exiting the bottle should be equal to the gas volume entering the bottle).

 **Pressure build-up will affect the measured CO₂ concentration, as CO₂ concentration is pressure-dependent.**

Sample from the bottle near the bottom with the gas analyzer.

PASS: CO₂ concentration measured must be between 98.0% – 100%.

 **The use of CO₂ gas with moisture will damage the flow sensors. Moisture level must be verified on the gas manufacturer's certificate: only 0.0 ppm v/v Max is permissible.**

31.2.1 About CO₂

Carbon dioxide (CO₂) is a colorless, odorless, non-combustible gas. Carbon dioxide above the triple point temperature of -56.6 °C and below the critical point temperature of 31.1 °C can exist in both a gaseous and a liquid state.

Bulk liquid carbon dioxide is commonly maintained as a refrigerated liquid and vapor at pressures between 1,230 kPa (approx. 12 bar) and 2,557 kPa (approx. 25 bar). Carbon dioxide may also exist as a white opaque solid with a temperature of -78.5 °C under

atmospheric pressure.



A high concentration of carbon dioxide (10.0% or more) can asphyxiate quickly without warning with no possibility of self-rescue regardless of the oxygen concentration.

The User should make sure the CO₂ used is safe and moisture-free. Below is a list of some standard component concentrations. Please note that the values given are NOT the proper amounts, only an example:

- Assay 99.9% v/v min.
- Moisture 50 ppm v/v max. (20 ppm w/w max).
- Ammonia 2.5 ppm v/v max.
- Oxygen 30 ppm v/v max.
- Oxides of Nitrogen (NO/NO₂) 2.5 ppm v/v max each.
- The non-volatile residue (particulates) 10 ppm w/w max.
- The non-volatile organic residue (oil and grease) 5 ppm w/w max.
- Phosphine 0.3 ppm v/v max.
- Total volatile hydrocarbons (calculated as methane) 50 ppm v/v max. of which 20 ppm v/v.
- Acetaldehyde 0.2 ppm v/v max.
- Benzene 0.02 ppm v/v max.
- Carbon Monoxide 10 ppm v/v max.
- Methanol 10 ppm v/v max.
- Hydrogen Cyanide 0.5 ppm v/v max.
- Total Sulphur (as S) 0.1 ppm v/v max.

31.3 Gas supply N₂ (only for models with a built-in gas mixer)

For the regulation to maintain the correct O₂ concentration levels in the Multi-zone ART Workstation MIRI® compartments, the device must be connected to a stable source of 100% N₂ at 0.4 – 0.6 bar (5.80 – 8.70 PSI) of pressure.

Measure the N₂ concentration in the gas supply by routing the gas line into a bottle without a lid and a suitably large opening. Set the pressure/flow so that the bottle is flushed continually with gas, without increasing pressure in the bottle (i.e., the amount of gas exiting the bottle should be equal to the gas volume entering the bottle).

Sample from the bottle near the bottom with the gas analyzer.



A gas analyzer that can measure 0% O₂ accurately can be used. 100% N₂ = 0 % O₂.

PASS: N₂ concentration measured must be between 95.0%– 100%.



The use of N₂ gas with moisture will damage the flow sensors. Moisture level must be verified on the gas manufacturer's certificate: only 0.0 ppm v/v Max is permissible.

31.3.1 About N₂

Nitrogen makes up a significant portion of the earth's atmosphere with 78.08% by volume. Nitrogen is a colorless, odorless, tasteless, non-toxic, and almost inert gas. Nitrogen is principally shipped and used in either gaseous or liquid form.



N₂ gas can act as a simple asphyxiant by displacing air.

The User should make sure the N₂ used is safe and moisture-free. Below is a list of some standard component concentrations. Please note that the values given are NOT the proper amounts, only an example:

- Research Grade 99.9995%.
- Contaminant.
- Argon (Ar) 5.0 ppm.
- Carbon Dioxide (CO₂) 1.0 ppm.
- Carbon Monoxide (CO) 1.0 ppm.
- Hydrogen (H₂) 0.5 ppm.
- Methane 0.5 ppm.
- Oxygen (O₂) 0.5 ppm.
- Water (H₂O) 0.5 ppm.

31.4 Premixed gas pressure check

The Multi-zone ART Workstation, with and/or without a built-in gas mixer, requires a pressure of 0.4 – 0.6 bar (5.80 – 8.70 PSI) on the input gas line. Therefore, the gas pressure must be held stable at all times.

For safety, this unit has a built-in digital gas pressure sensor that monitors the incoming gas pressure and alerts the User if any drop is detected.

Remove the inlet gas line for the gas. Attach the gas line to the gas pressure measuring device.

Remove the inlet gas line for the CO₂ gas. Attach the gas line to the gas pressure measuring device.

PASS: The value must be 0.4 – 0.6 bar.

Please refer to the User manual sections for more information.

31.5 CO₂ gas pressure check (only for models with a built-in gas mixer)

The Multi-zone ART Workstation requires a pressure of 0.4 – 0.6 bar (5.80 – 8.70 PSI) on the input gas line. Therefore, the gas pressure must be held stable at all times.

For safety, this unit has a built-in digital gas pressure sensor that monitors the incoming gas pressure and alerts the User if any drop is detected.

Remove the inlet gas line for the CO₂ gas. Attach the gas line to the gas pressure measuring device.

PASS: The value must be 0.4 – 0.6 bar.

Please refer to the User manual sections for more information.

31.6 N₂ gas pressure check (only for models with a built-in gas mixer)

The Multi-zone ART Workstation requires a pressure of 0.4 – 0.6 bar (5.80 – 8.70 PSI) on the input gas line. Therefore, the gas pressure must be held stable at all times.

For safety, this unit has a built-in digital gas pressure sensor that monitors the incoming gas pressure and alerts the User if any drop is detected.

Remove the inlet gas line for the N₂ gas. Attach the gas line to the gas pressure measuring device.

PASS: The value must be 0.4 – 0.6 bar.

Please refer to the User manual sections for more information.

31.7 Voltage supply

The voltage on-site must be verified.

Measure the output plug on the UPS that the Multi-zone ART Workstation will be connected to. Also, check that the UPS is attached to a properly grounded mains outlet.

Use a multimeter set for AC.

PASS: 230V ± 10.0%
115V ± 10.0%

31.8 Temperature check: Heating system zones

The temperature validation is performed using a thermometer with a sensor suitable for measuring temperature on a stainless steel surface with a resolution of 0.1 °C as a minimum. Tape the sensor is placed in the middle position of the heating zone. Make sure that the tape keeps the sensor in complete contact with the surface area.

 **Taping on the sensors is an in-optimal procedure as the tape itself will insulate from the airflows and thus not represent an entirely perfect picture. It is, however, a usable compromise if the size of the taped area is kept small and the tape used is strong, thin and light.**

Place the sensor on each zone and verify the temperature. For temperature validation in the MIRI® compartments, tape the sensor in the middle of the compartment and/or lid.

PASS: all temperatures measured on the bottom of the compartments where the dishes are located must not deviate more than ± 0.2 °C from the setpoint.

If calibration is needed, please refer to the "12.5.1 Temperature sub-menu" section for more information on how to perform the temperature calibration.

 **An iterative process may be needed if differences in the temperature levels are found and compensated through the calibration procedures. Bottom and lid temperatures will affect each other to some extent. There will be no crossover heat noticeable between compartments.**

31.9 6-hour stability test

Following the careful validation of the single parameter, a 6-hour (minimum duration) check must be initiated.

The device must be set up as closely as the condition under which it will be running in clinical use.

Make sure that the Esco Medical data logger software is running.

Check that parameter are logged and give a meaningful reading. Let the device run without interfering for at least 6 hours. Then, analyze the results on the graphs.

Pass I: Internal sensor temperature variation from set point is within ± 0.1 °C absolute.

Pass II: if gas is attached, monitor that the gas pressure stays within ± 0.1 bar of 0.5 bar

The below list is only applicable for Multi-zone ART Workstation with a built-in gas mixer

Pass III Internal sensor CO₂ concentration variation from setpoint within $\pm 0.2\%$ absolute.

Pass IV: Internal sensor N₂ concentration variation from setpoint within $\pm 0.2\%$ absolute.

Pass V: Gas flow CO₂ less than 2 l/h.

Pass VI: Gas flow N₂ less than 8 l/h.

31.10 Cleaning

 **Always validate the cleaning procedures locally or consult the manufacturer or the distributor for more guidance.**

After the testing has been conducted successfully, it should be cleaned again before it is taken into clinical use.

Inspect the unit for physical signs of dirt or dust. The unit should look generally tidy.

- Clean the unit externally with a lint-free cloth moistened with a 70% alcohol solution.
- Switch off the device and remove the mains lead.
- Wipe the inside of the Multi-zone ART Workstation (the surface of the work area and the compartments) with a lint-free cloth moistened with a 70% alcohol solution.
- Wipe the lids in the same way.
- Let the lids remain open for 5 minutes.
- Wipe the same areas with a lint-free cloth moistened with sterilized water.
- Wipe the lids in the same way.
- Let the lids remain open for 10 minutes.
- Close the lids.
- Attach the power again and switch on the fan.
- Let the Multi-zone ART Workstation run empty for at least 20 minutes before inserting samples.

31.11 Test documentation form

 **The "Installation report" form must be completed with the tests-passed status filled by installation personnel and submitted to Esco Medical before the device is taken into clinical use.**

31.12 Recommended additional testing

31.12.1 A VOC meter

A sample should be taken in the room in front of the Multi-zone ART Workstation with the VOC meter. The reading should be noted down as the background VOC level. Then inside the work area, a sample should be made. A sample should also be made from under the gas hood with the gas system running.

Pass: 0.0 ppm VOC

 **Ensure that the sample lines do not contain any VOC.**

31.12.2 A laser particle counter

A sample should be taken in front of the Multi-zone ART Workstation with the laser particle counter. The reading should be noted down as the background particle level. Then with the fan switched on, a sample should be taken inside the work area with the sample opening pointing towards the side of the work area (either left or right).

Pass: 0.3-micron < 100 ppm.

 **Ensure that the sample lines do not contain any particles.**

32 Clinical use

Congratulations! Your device is now ready for clinical use with the validation tests completed and the test report submitted to Esco Medical.

It should provide many years of stable service.

It is necessary to monitor the performance of the device continually.

Use the below scheme for in-use validation.

 **Do not attempt to run Multi-zone ART Workstation for clinical purposes without access to high-grade quality control validation equipment.**

Table 32.1 Validation intervals

| Task | Every day | Every week |
|--|-----------|------------|
| Temperature check | | X |
| Premixed, CO ₂ and O ₂ gas concentration check | X | |
| Check log for anomalies | | X |
| Premixed, CO ₂ and N ₂ gas pressure check | X | |

32.1 Temperature check

The temperature check is performed using a high-precision thermometer. Place the thermometer on each zone and verify the temperature. Calibrate if necessary.

Please refer to the "12.5.1 Temperature sub-menu" section for more information on how to perform the temperature calibration.

PASS:

- **All temperatures measured on the bottom of the compartment in the locations where the dishes would be placed must not deviate more than ± 0.2 °C from the set point**
- **All temperatures measured on the lid must not deviate more than ± 0.5 °C from the setpoint.**

32.2 Premixed, CO₂ and O₂ gas concentration check

The gas concentration is checked for deviations. For Multi-zone ART Workstation, without MIRI® compartments, the sample is taken from under the gas hood with the gassing system running. For Multi-zone ART Workstation, with MIRI® compartments, the sample is taken from one of the sample ports located in the back of the unit.

It is essential to have a high-precision gas analyzer for CO₂ and O₂ available to do the test.

Please follow these simple rules while testing gas concentration in MIRI® compartments:

- Check the CO₂/O₂ gas setpoint.
- Check the actual CO₂/O₂ gas concentration to ensure that the setpoint is reached and gas concentration is stabilized around the setpoint.
- Remember not to open the lid for at least 10 min, before starting the test or during the testing itself.

Please refer to the "12.5.2 CO₂ sub-menu (only for models with a built-in gas mixer)" / "12.5.3 O₂ sub-menu (only for models with a built-in gas mixer)" section for more information on how to perform the CO₂/O₂ gas calibration.

PASS:

- **The concentration measured must not deviate more than $\pm 0.3\%$ from the concentration given on the premixed gas bottle label.**
- **CO₂ concentration measured must not deviate more than $\pm 0.2\%$ from the setpoint.**

32.3 Premixed, CO₂ and O₂ gas pressure check

The Multi-zone ART Workstation requires a pressure of 0.4 – 0.6 bar on the input gas line. This gas pressure must be held stable at any time.

For safety reasons, this unit has a built-in digital gas pressure sensor control that monitors the incoming gas pressure and alerts the user if any drop is detected.

It is recommended to check the gas pressure in the Multi-zone ART Workstation data logger.

PASS: The value must be 0.4 – 0.6 bar.

Please refer to the user manual for more information.

33 The Maintenance guide

The Multi-zone ART Workstation from Esco Medical contains high precision quality components. These components are chosen to ensure the high durability and performance of the equipment.

However, continual validation of the performance is necessary.

User validation should be done as a minimum according to instructions given in the "29 The Validation guide" section.

If problems are encountered, contact Esco Medical or your local representative.

However, to sustain the high-performance level and avoid system errors, the owner is responsible for having a certified technician who performs components replacements, according to table 33.1.

These components must be replaced in the time intervals specified below. Failure to follow these instructions may, in the worst-case scenario, result in damage to the specimens in the incubator.



Warranty void if service intervals are not followed according to table 33.1.



Warranty void if non-original parts are used or non-trained and non-authorized personnel carry out the servicing.

The table below shows time intervals in which components must be replaced.

Table 33.1 Service interval plan

| Component name | Every year | Every 2 years | Every 3 years | Every 4 years |
|--|------------|---------------|---------------|---------------|
| HEPA in-line filter for premixed gas | X | | | |
| HEPA in-line filter for CO ₂ gas ¹ | X | | | |
| HEPA in-line filter for N ₂ gas ¹ | X | | | |
| O ₂ sensor ¹ | X | | | |
| CO ₂ sensor ¹ | | | | X |
| Gas box ² | | X | | |
| Internal gas pump | | X | | |
| Proportional valves | | | X | |
| Gas lines | | | X | |
| Flow sensors | | X | | |
| Pressure regulators | | | | X |
| Internal 0.2μ filter for premixed gas | X | | | |
| Internal 0.2μ filter for CO ₂ ¹ | X | | | |
| Internal 0.2μ filter for N ₂ ¹ | X | | | |
| A firmware update (if a new version has been released) | X | | | |

33.1 HEPA in-line filter for premixed gas

The round-shape in-line 0.2μ HEPA filter for premixed gas removes any particles found in the incoming gas. Failure to use the HEPA filter may cause damage to the high precision flow sensor, which calculates the amount of gas entering the system and disturbing the gas flow system.

Please follow these safety precautions when changing the filter:

- Always use the original filter (contact Esco Medical or your local distributor for more details or ordering).
- Change the filter once every year.
- Failure to change the filter on time will result in low/no cleaning of incoming premixed gas.
- Warranty void if wrong/ non-original filter is used.

Please refer to the service manual for replacement instructions.

33.2 HEPA in-line filter for CO₂ gas

The round-shape in-line 0.2μ HEPA filter for CO₂ gas removes any particles found in the

¹ Applicable only for Multi-zone ART Workstation with a built-in gas mixer

² Applicable only for Multi-zone ART Workstation without a built-in gas mixer

incoming gas. Failure to use the HEPA filter may cause damage to the high precision flow sensor, which calculates the amount of gas entering the system and disturbing the gas flow system.

Please follow these safety precautions when changing the filter:

- Always use the original filter (contact Esco Medical or your local distributor for more details or ordering).
- Change the filter once every year.
- Failure to change the filter on time will result in low/no cleaning of incoming CO₂ gas.
- Warranty void if wrong/ non-original filter is used.

Please refer to the service manual for replacement instructions.

33.3 HEPA in-line filter for N₂ gas

The round-shape in-line 0.2μ HEPA filter for N₂ gas removes any particles found in the incoming gas. Failure to use the HEPA filter may cause damage to the high precision flow sensor, which calculates the amount of gas entering the system and disturbing the gas flow system.

Please follow these safety precautions when changing the filter:

- Always use the original filter (contact Esco Medical or your local distributor for more details or ordering).
- Change the filter once every year.
- Failure to change the filter on time will result in low/no cleaning of incoming N₂ gas.
- Warranty void if wrong/ non-original filter is used.

Please refer to the service manual for replacement instructions.

33.4 O₂ sensor (only for models with a built-in gas mixer)

The oxygen regulation uses the Oxygen sensor to keep the O₂ gas concentration at a desired level inside the chambers. The lifetime of this sensor is limited due to its construction. From the day the sensor is unpacked, a chemical process is activated within the sensor core. The chemical reaction is entirely harmless to its surroundings, but it is necessary for measuring the amount of oxygen with very high precision needed in the Multi-zone ART Workstation, with a built-in gas mixer.

After 1-year, the chemical process in the sensor core stops and the sensor must be

replaced. Therefore, it is essential to replace this sensor **WITHIN year from the date it was unpacked and installed.**

 **Oxygen sensors must be replaced at least once every year from the date they were installed in the unit, irrespective of the incubator being used or not.**

The User will see when this sensor was installed in the Multi-zone ART Workstation "Installation report" form. This date must be used to calculate the date for the following O₂ sensor change.

Please follow these safety precautions when changing sensor:

- Always use an original O₂ sensor (contact Esco Medical or your local distributor for more details or ordering).
- Change the O₂ sensor within 1 year from the date of the previous sensor installation.
- Failure to change the oxygen sensor on time will result in low/no regulation of O₂ concentration.
- Warranty void if wrong/ non-original sensor is used.

Please refer to the service manual for replacement instructions.

33.5 CO₂ sensor (only for models with a built-in gas mixer)

The CO₂ regulation uses the CO₂ sensor to keep the gas concentration at the chambers' desired level.

This sensor's lifetime is more than 6 years, but for safety reasons, Esco Medical recommends the sensor to be replaced once every 4-years.

Please follow these safety precautions when changing the sensor:

- Always use an original CO₂ sensor (contact Esco Medical or your local distributor for more details or ordering).
- Change the CO₂ sensor within 4 years from the date of installation.
- Failure to change the CO₂ sensor on time can result in low/no CO₂ gas concentration regulation.
- Warranty void if wrong/ non-original sensor is used.

Please refer to the service manual for replacement instructions.

33.6 Gas box (only for models without a built-in gas mixer)

The gas box is used only in the Multi-zone ART Workstation without a built-in gas mixer. It is needed to ensure internal gas circulation in the system.

Therefore, the gas box must be replaced once every 2 years to maintain proper gas circulation in the system.

Please follow these safety precautions when changing the internal gas pump:

- Always use an original gas pump (contact Esco Medical or your local distributor for more details or ordering).
- Change the gas box within 2 years from the date of installation.
- Failure to change the gas box may cause bad gas circulation.
- Warranty void if wrong/ non-original pump is used.

Please refer to the service manual for replacement instructions.

33.7 Internal gas pump

The internal gas pump is used to transport the mixed gas through the chambers. In time the performance of this pump can be affected, causing a longer recovery time.

Therefore, this pump must be replaced once every 2 years to maintain the fast recovery time after lid openings.

Please follow these safety precautions when changing the internal gas pump:

- Always use an original gas pump (contact Esco Medical or your local distributor for more details or ordering).
- Change the gas pump within 2 years from the date of installation.
- Failure to change the pump may cause slow recovery times or breakdowns.
- Warranty void if wrong/ non-original pump is used.

Please refer to the service manual for replacement instructions.

33.8 Proportional valves

The internal valves make gas regulation possible. If the proportional valves are worn, gas regulation may be affected. It may cause more prolonged recovery time, incorrect gas concentration or breakdown. Therefore, these proportional valves must be replaced once every 3 years to maintain system safety and stability.

Please follow these safety precautions when changing valves:

- Always use original proportional valves (contact Esco Medical or your local distributor for more details or ordering).
- Change the valves within 3 years from the date of installation.
- Failure to change the valves may cause slow recovery times or breakdowns.
- Warranty void if wrong/ non-original valves are used.

Please refer to the service manual for replacement instructions.

33.9 Gas lines

The internal gas lines are used to transport mixed gas through the HEPA filter and the chambers. Over time, the lines' performance can be affected, causing more extended recovery time due to clogging.

Therefore, the gas lines must be replaced once every 3 years to maintain the fast recovery time after lid opening.

Please follow these safety precautions when changing gas lines:

- Always use original gas lines (contact Esco Medical or your local distributor for more details or ordering).
- Change the gas lines within 3 years from the date of installation.
- Failure to change the gas lines may cause slow recovery times or breakdowns.
- Warranty void if wrong/ non-original gas lines are used.

Please refer to the service manual for replacement instructions.

33.10 Flow sensors

The digital gas humidification system uses flow sensors for the premixed gas.

The flow sensors are used by the CO₂/N₂ regulations and for logging the unit's gas consumption (applicable in the Multi-zone ART Workstation with a built-in gas mixer).

This sensor's lifetime is more than 3 years, but Esco Medical recommends the sensor to be replaced once every 2 years for safety reasons.

Please follow these safety precautions when changing sensors:

- Always use an original flow sensor (contact Esco Medical or your local distributor for more details or ordering).

- Change flow sensors within 2 years from the date of installation.
- Failure to change the flow sensors on time may result in low/no premixed gas, CO₂ and O₂ gas concentration regulation.
- Warranty void if wrong/ non-original sensors are used.

Please refer to the service manual for replacement instructions.

33.11 Pressure regulators

The internal pressure regulators protect the system from too high external gas pressures that damage the gas circuit's sensitive parts. If the pressure regulators are worn, they may begin to drift and not offer the protection they are supposed to. It could cause breakdowns or leaks in the internal gas circuit. Therefore, the regulators must be replaced once every 4 years to maintain the system safe and stable.

Please follow these safety precautions when changing regulators:

- Always use original pressure regulators (contact Esco Medical or your local distributor for more details or ordering).
- Change the regulators within 4 years from the date of installation.
- Failure to change the regulators may cause breakdowns.
- Warranty void if wrong/ non-original regulators are used.

Please refer to the service manual for replacement instructions.

33.12 Internal 0.2μ filter for premixed gas

The round-shape in line 0.2μ HEPA filter for premixed gas removes any particles found in the incoming gas. Failure to use the HEPA filter may cause damage to the high precision flow sensor, which calculates the amount of gas entering the system and disturbing the gas flow system.

Please follow these safety precautions when changing the filter:

- Always use the original filter (contact Esco Medical or your local distributor for more details or ordering).
- Change the filter once every year.
- Failure to change the filter on time will result in low/no cleaning of incoming premixed gas.
- Warranty void if wrong/ non-original filter is used.

Please refer to the service manual for replacement instructions.

33.13 Internal 0.2 μ filter for CO₂ gas

The round-shape in line 0.2 μ HEPA filter for CO₂ gas removes any particles found in the incoming gas. Failure to use the HEPA filter may cause damage to the high precision flow sensor, which calculates the amount of gas entering the system and disturbing the gas flow system.

Please follow these safety precautions when changing the filter:

- Always use the original filter (contact Esco Medical or your local distributor for more details or ordering).
- Change the filter once every year.
- Failure to change the filter on time will result in low/no cleaning of incoming CO₂ gas.
- Warranty void if wrong/ non-original filter is used.

Please refer to the service manual for replacement instructions.

33.14 Internal 0.2 μ filter for N₂ gas

The round-shape in line 0.2 μ HEPA filter for N₂ gas removes any particles found in the incoming gas. Failure to use the HEPA filter may cause damage to the high precision flow sensor, which calculates the amount of gas entering the system and disturbing the gas flow system.

Please follow these safety precautions when changing the filter:

- Always use the original filter (contact Esco Medical or your local distributor for more details or ordering).
- Change the filter once every year.
- Failure to change the filter on time will result in low/no cleaning of incoming N₂ gas.
- Warranty void if wrong/ non-original filter is used.

Please refer to the service manual for replacement instructions.

33.15 Firmware update

If Esco Medical has released a newer version of the firmware, this should be installed on the Multi-zone ART Workstation during the yearly scheduled service.

Please refer to the service manual for instructions on how to update the firmware.

34 The Installation guide

This document describes when and how to install Multi-zone ART Workstation in the IVF clinic.

34.1 Responsibilities

All technicians or embryologists installing the Multi-zone ART Workstation must identify problems and perform any necessary calibrations, adjustments and maintenance.

All individuals who will perform installation, repair and/or maintenance of the instrument must be trained by Esco Medical or a qualified training center. Experienced service technicians or embryologists conduct training to ensure that the installation personnel clearly understand the instrument's functions, performance, testing, and maintenance.

Installation personnel must be updated regarding alterations or additions to this document and the "Installation report" form.

34.2 Before installation

2 – 3 weeks before the installation due, the user/owner at the clinic is contacted via e-mail to plan the exact time to perform the installation. When a convenient time has been determined, travel and accommodation arrangements can be made.

The released Multi-zone ART Workstation must be sent 1 – 3 weeks before installation, depending on the clinic location. Check with shippers about local customs regulations and delays that could arise from that.

The clinic must be informed about the site requirements before installation and should have signed the customer requirement checklist:

1. The lab must have an open and flat lab floor space for standing operation.
2. The weight of the 4-ft Multi-zone ART Workstation is 225 kg, and the 6-ft is 345 kg.
3. The required space for placement is provided in the "27 Specifications" section tables.
4. Temperature control should be able to maintain a stable temperature, never exceeding 30 °C.
5. Uninterrupted power supply (UPS) with 115 or 230 V, minimum 120 W.
6. Proper grounding.
7. Premixed and CO₂ gas outlet with 0.6 – 1.0 atm above ambient.

8. N₂ gas outlet with 0.6 – 1.0 atm above ambient if the clinic uses reduced oxygen levels.
9. Tubes that fit 4 mm hose nipple and HEPA filter.
10. Access to a PC with USB for the data logging.

34.3 Preparing for installation

- Bring the "Installation report" form. Make sure it is the latest and current version only.
- Fill out the following blank boxes in the form: the Multi-zone ART Workstation serial number (S/N) and customer.
- The service tool kit is checked for content before every installation trip to ensure it contains the necessary tools.
- Always bring the latest versions of firmware and data logging software. Bring these files on a labeled memory stick to the service site.

34.4 Bring the following to the installation site

- "Installation report" form.
- Service manual for the Multi-zone ART Workstation.
- Updated service tool kit.
- Memory stick with the latest released firmware & software.
- High precision thermometer with a resolution not less than 0.1 °C.
- Calibrated gas analyzer with precision at least 0.1% for CO₂ and O₂
- Extension cable for USB connection.

34.5 Installation procedure at the site

1. Lift the cabinet using a stacker or forklift

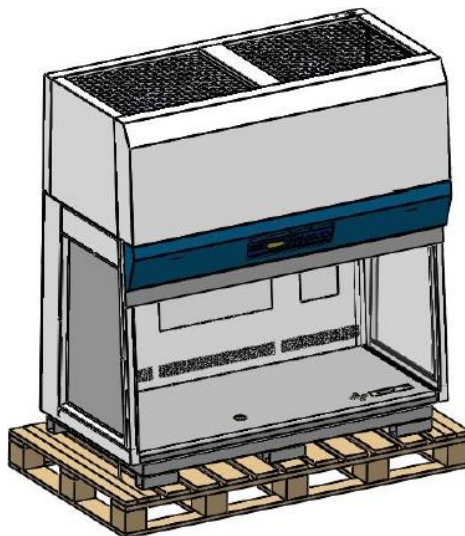

Figure 34.1 Multi-zone ART Workstation, cabinet

2. Position the pre-assembled support stand below the cabinet.

 **Do not lower the cabinet onto the support stand yet.**

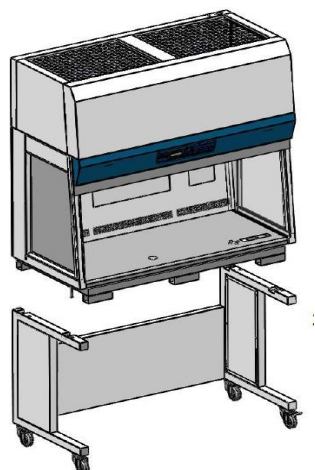

Figure 34.2 Multi-zone ART Workstation, cabinet and support stand

3. Remove the 4 bolts as shown below.

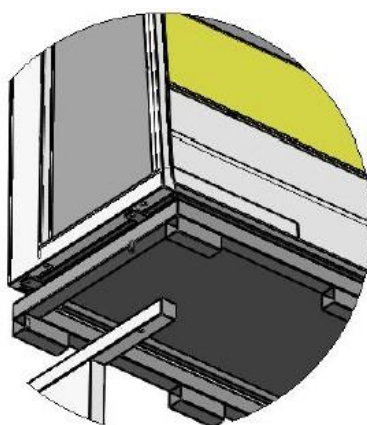

Figure 34.3 4 bolts in the Multi-zone ART Workstation cabinet

4. Lower the cabinet slowly and carefully onto the support stand. Ensure the support stand is aligned correctly with the cabinet.
5. Secure the support stand to the cabinet using the 4 long bolts.

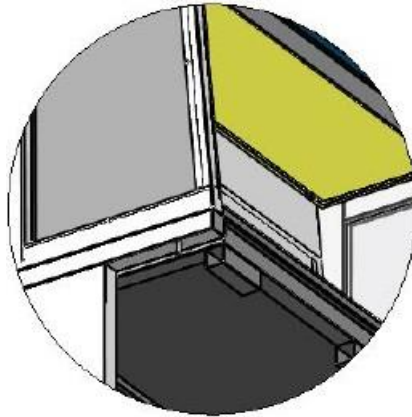

Figure 34.4 4 long bolts in the Multi-zone ART Workstation cabinet

6. Unscrew the 4 bolts as shown below and remove the 4 pcs of angle brackets.

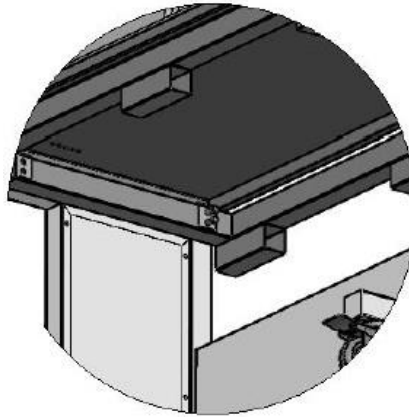

Figure 34.5 4 pcs of angle brackets removal

7. Pull out the metal pallet. The installation is now completed.

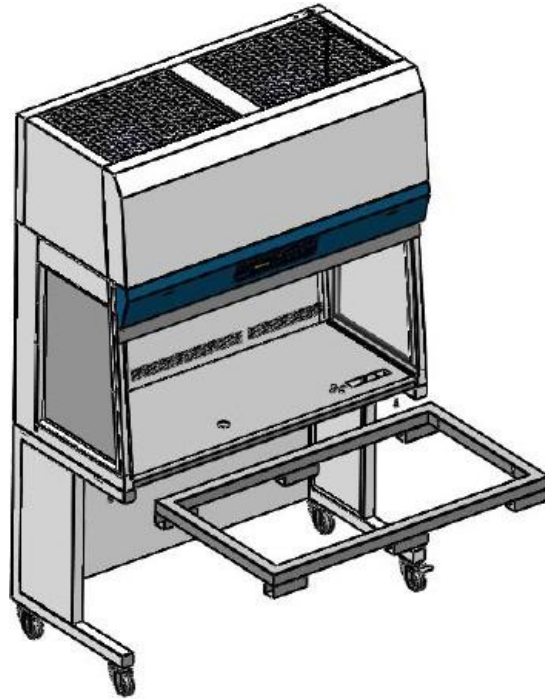

Figure 34.6 Metal pallet in the Multi-zone ART Workstation

34.6 Installation procedure: Workstation

1. Follow the guidelines in the safety instructions and warnings section ("2 Safety warning" section).
2. Insert the computer into the frame from the backside. Connect the cables to suitable positions.



Figure 34.7 Cable connection in the back of the Multi-zone ART Workstation

3. Connect the power cable to the UPS.
4. Connect the main power cable to the Multi-zone ART Workstation.



Figure 34.8 Main power connection in the Multi-zone ART Workstation

5. Use the gas hose, connect it to the Multi-zone ART Workstation and secure the gas lines.



Figure 34.9 Gas line connection under the tabletop

6. Set gas pressure on the external gas regulator at 0.4 – 0.6 bar (5.80 – 8.70 PSI).
7. Switch on the Multi-zone ART Workstation by pressing the button on the back.

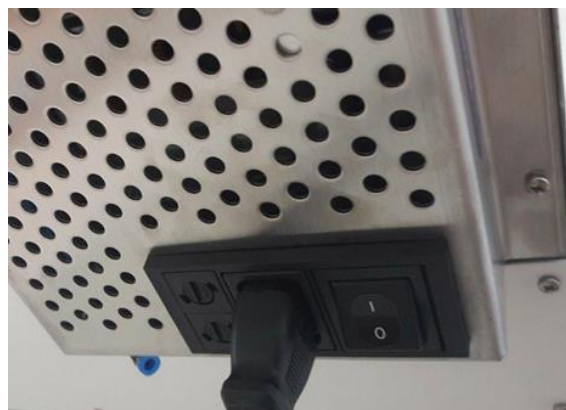

Figure 34.10 Power button on the back of the Multi-zone ART Workstation

8. Observe for standard functionality.
9. Let the unit warm up and stabilize for 20 min.
10. Follow the guidelines in the "29 The Validation guide" section.
11. Complete user training and finish reading instructions.
12. After a burn-in phase of 24-hours, the unit is ready for use IF the testing is successful.

If there are any deviations from the values included in the test form, they must be discussed with the user or owner of the Multi-zone ART Workstation.

If there are any suggestions or complaints, these must be recorded in the installation report form.

34.7 User training

1. Mains switch on/off.
2. Explain the essential function of Multi-zone ART Workstation with room facility for storing the samples.
3. Explain the temperature control in the Multi-zone ART Workstation (direct heat transfer with heated lids).
4. Gas regulation on/off.
5. Setpoint for temperature, CO₂ and O₂.
6. Alarm turn-off procedure (temperature, CO₂, O₂ or Premix gas) and revert times.
7. Insertion and removal of heating inserts
8. Emergency procedures (can be found in the "25 Emergency Procedures" section).
9. Explain how to clean the device and heating inserts.
10. External measurement and calibration of temperature.
11. External measurement and calibration of gas concentration.
12. How to add and remove a sample.
13. Data logger functionality, how to establish a connection and re-connection.

 **Use the User manual section as much as possible to get the User well acquainted with it.**

34.8 After the installation

When the installation trip is finished, a copy of the original "Installation report" form must be sent to Esco Medical Ltd. It will be saved with the device records. According to the ISO procedure and Medical Device Directive, a paper copy of the completed and signed installation test form is stored in the unique device's device history record. The date of installation is written in the instrument overview file. The date of installation is also written in the service schedule.

Suppose the Multi-zone ART Workstation user or owner inquiries about a written

"Installation report". The completed and signed "Installation report" form must be sent to the clinic. Any deviations/complaints/suggestions from the Installation visit are reported in the CAPA system. If a critical error has occurred, information about this will be reported directly to QC or QA.



If the Multi-zone ART Workstation fails any of the "Installation report" form acceptance criteria, or it in any way suffer from a severe error and incubation parameters are compromised, the Multi-zone ART Workstation must be taken out of service until it is repaired/exchanged, or anew test approves the Multi-zone ART Workstation. The User and owner must be informed about this and arrangements to solve the problems must be initiated.